



OPERATING AND ATEX/IECEX SAFETY INSTRUCTIONS

KATflow 170 – Aluminium Enclosure

Clamp-On Ultrasonic Flowmeter for Hazardous Areas



KATflow 170

Operating Instructions

Katronic Technologies Ltd.
Earls Court
Warwick Street
Coventry CV5 6ET
United Kingdom

Tel. +44 (0)2476 714 111
Fax +44 (0)2476 715 446
E-mail info@katronic.co.uk
Web www.katronic.co.uk

TABLE OF CONTENTS

1 SAFETY INSTRUCTIONS, LEGAL REQUIREMENTS, WARRANTY, RETURN POLICY	5	4.3 Cable glands	26
1.1 Symbols	5	4.4 Equipotential bonding	27
1.2 Safety instructions for the operator	5	4.4.1 Clamp-on ultrasonic sensors	27
1.3 Languages/translations	6	4.4.2 Flowmeter	27
1.4 Warranty	6	4.5 Process inputs/outputs	27
1.5 Return policy	6	5 OPERATION	28
1.6 Legislative requirements	7	5.1 Switching On/Off	28
2 INTRODUCTION	8	5.2 Keypad and display	28
2.1 Clamp-on transit-time flowmeter	8	5.2.1 Keypad key functions	29
2.2 Measuring principle	8	5.2.2 Display icons and functions	30
2.3 Approvals	9	5.3 Quick Setup Wizard	31
2.3.1 Clamp-on ultrasonic sensors	9	5.4 Measurement	33
2.3.2 Flowmeter	10	5.4.1 Main process value display	33
2.4 Temperature limits	11	5.4.2 Three-line display	33
2.4.1 Clamp-on ultrasonic sensors	11	5.4.3 Totaliser	33
2.4.2 Flowmeter	11	5.4.4 Diagnostic display	34
2.5 Special conditions of safe use	12	5.4.5 Dual-channel measurement screen	34
2.6 EU type examination certificates	12	5.4.6 "Math" display	35
3 INSTALLATION	13	5.4.7 Data logger	35
3.1 Unpacking and storage	13	6 COMMISSIONING	36
3.1.1 Unpacking	13	6.1 Menu structure	36
3.1.2 Storage	13	6.2 Output configuration	46
3.1.3 Identification of components	13	6.2.1 Serial interface	46
3.2 System configuration	14	6.2.2 Modbus RTU	46
3.3 Clamp-on sensor installation	15	6.2.3 HART® compatible output	47
3.3.1 Acoustic propagation	15	6.2.4 Analogue current output 0/4 ... 20 mA	47
3.3.2 Straight pipe lengths	16	6.2.5 Analogue voltage output 0 ... 10 V	49
3.4 Installation location	16	6.2.6 Analogue frequency output (passive)	49
3.5 Pipe preparation	18	6.2.7 Digital open-collector output	50
3.6 Sensor mounting configurations and separation distance	19	6.2.8 Digital relay output	50
3.6.1 Reflection Mode	19	6.3 Input configuration	51
3.6.2 Diagonal Mode	19	6.3.1 Pt 100 inputs	51
3.6.3 Transducer separation distance	19	6.3.2 Analogue current input 0/4 ... 20 mA	51
3.7 Sensor installation in hazardous areas	20	6.4 Temperature compensation	51
3.7.1 Acoustic coupling gel	20	6.5 Heat quantity measurement	52
3.7.2 Correct positioning of the sensors	21	6.6 Sound velocity measurement	52
3.7.3 Sensor mounting with tension straps	22	6.7 Dual-channel flow calculations	52
3.8 Flowmeter installation in hazardous areas	23	6.8 Scope function	52
3.9 Flowmeter installation	24	6.9 KATdata+ software	53
3.9.1 Outline dimensions	24	7 MAINTENANCE	54
4 ELECTRICAL INSTALLATION	25	7.1 Opening/closing the Ex d compartment	54
4.1 Electrical wiring	25	7.2 Service/Repair	54
4.2 Cabling and junction box	26	8 TROUBLESHOOTING	56
4.2.1 Signal cable parameters	26	8.1 Measurement difficulties and error messages	56
		8.2 Data download difficulties	58
		9 TECHNICAL DATA	59

KATflow 170

TABLE OF CONTENTS

9.1 Sound speed of selected pipe materials	59	10.5 Communication	67
9.2 Technical data of selected fluids	60	10.6 KATdata+ software	67
9.3 Dependence between temperature and sound speed in water	63	10.7 Process inputs	68
10 SPECIFICATION	66	10.8 Process outputs	68
10.1 General	66	10.9 Clamp-on sensors: K1Ex, K4Ex	69
10.2 Flowmeter	66	11 INDEX	70
10.3 Quantity and units of measurement	67	12 APPENDIX A – Certificate of Conformity	71
10.4 Internal data logger	67	13 APPENDIX B – Customer Return Note (CRN)	73

SAFETY INSTRUCTIONS, LEGAL REQUIREMENTS, WARRANTY, RETURN POLICY

1 SAFETY INSTRUCTIONS, LEGAL REQUIREMENTS, WARRANTY, RETURN POLICY

1.1 Symbols



Danger

This symbol represents an immediate hazardous situation which could result in serious injury, death or damage to the equipment. Where this symbol is shown, do not use the equipment further unless you have fully understood the nature of the hazard and have taken the required precautions.



Ex-hazard

This warning refers to an immediate danger when using the equipment in a hazardous area.



Attention

This symbol indicates important instructions which should be respected in order to avoid damaging or destroying the equipment. Follow the precautions given in these instructions to avoid the hazard. Call our service team if necessary.



Call service

Where this symbol is shown call our service team for advice if necessary.



Note

This symbol indicates a note or detailed setup tip.

ESC

Operator key

Operator keys are printed in bold typeface.

1.2 Safety instructions for the operator



These safety instructions are applicable for sensor type K1Ex/K4Ex and KATflow 170 flowmeter installations in hazardous areas.

- Do not install, operate or maintain this flowmeter without reading, understanding and following these operating instructions, otherwise injury or damage may result.
- Study these operating instructions carefully before the installation of the equipment and keep them for future reference.
- Observe all warnings, notes and instructions as marked on the packaging, on the equipment, and detailed in the operating instructions.

KATflow 170

SAFETY INSTRUCTIONS, LEGAL REQUIREMENTS, WARRANTY, RETURN POLICY

- Do not change or alter the sensors or the transmitter. Unauthorised changes may affect the explosion safety of the equipment.
- The special conditions of use as described in the EU type examination certificate must be followed. In addition, all given electrical specifications must be met.
- The electrical installation must be in accordance with applicable national standards (equivalent to IEC 364) in addition to the requirements for installation in hazardous areas according to EN/IEC 60079-14 “Electrical installations in hazardous locations” or equivalent national standards.
- Installation, operation, service and maintenance of the equipment must only be performed by authorised and trained personnel with the necessary knowledge and qualifications in explosion safety.
- If the product does not operate normally, please refer to the service and troubleshooting instructions, or contact Katronic for help.

1.3 Languages/translations

These safety instructions are compiled in English. If English is not your native language and you have difficulties understanding the content of these instructions, please contact Katronic and/or your authorised local distributor for a translation of this text.

1.4 Warranty

- Any product purchased from Katronic is warranted in accordance with the relevant product documentation and as specified in the sales contract provided. This is subject to the condition that it has been used for the purpose for which it has been designed and operated as outlined in these operating instructions. Misuse of the equipment will immediately revoke any warranty given or implied.
- Responsibility for suitability and intended use of this ultrasonic flowmeter rests solely with the user. Improper installation and operation of the flowmeter may lead to a loss of warranty.
- Please note that there are no operator-serviceable parts inside the equipment. Any unauthorised interference with the product will invalidate the warranty.

1.5 Return policy

If the flowmeter has been diagnosed to have a problem, it can be returned to Katronic for repair using the Customer Return Note (CRN) attached to the Appendix of this manual. Katronic regret that for health and safety reasons we cannot accept the return of the equipment unless accompanied by the completed CRN.

SAFETY INSTRUCTIONS, LEGAL REQUIREMENTS, WARRANTY, RETURN POLICY

1.6 Legislative requirements



CE Marking

The flowmeter is designed to meet the safety requirements in accordance with sound engineering practice. It has been tested and has left the factory in a condition in which it is safe to operate. The equipment is in conformity with the statutory requirements of the EC directive and complies with applicable regulations and standards for hazardous area equipment (2014/34/EU), and for electrical safety (EN 61010) and electromagnetic compatibility (EN 61326). A CE Declaration of Conformity has been issued in that respect, a copy of which can be found in Appendix of these operating instructions.



WEEE Directive

The Waste Electrical and Electronic Equipment Directive (WEEE Directive 2012/19/EU) aims to minimise the impact of electrical and electronic goods on the environment by increasing re-use and recycling and by reducing the amount of WEEE going to landfill. It seeks to achieve this by making producers responsible for financing the collection, treatment, and recovery of waste electrical equipment, and by obliging distributors to allow consumers to return their waste equipment free of charge. Katronic offers its customers the possibility of returning unused and obsolete equipment for correct disposal and recycling. The dustbin symbol indicates that when the last user wishes to discard this product, it must be sent to appropriate facilities for recovery and recycling. By not discarding this product along with other household-type waste, the volume of waste sent to incinerators or landfills will be reduced and natural resources will be conserved. Please use the Customer Return Note (CRN) in the Appendix 13 for return to Katronic.



RoHS Directive

All products manufactured by Katronic are compliant with the relevant aspects of the RoHS Directive.

KATflow 170

INTRODUCTION

2 INTRODUCTION

2.1 Clamp-on transit-time flowmeter

The KATflow 170 is a fixed installation ultrasonic flowmeter designed for use in hazardous areas employing clamp-on sensors for the measurement of liquids in full, enclosed pipes. Flow measurements can be undertaken without interruption of the process or interference with the integrity of the pipeline. The clamp-on sensors are attached to the outside of the pipes. The KATflow 170 uses ultrasonic signals for measurement of the flow, utilising the transit-time method. The sensors of type K1Ex and K4Ex are equally suitable for use in hazardous areas. The KATflow 170 flowmeter can only be used with ATEX or IECEx certified sensors.

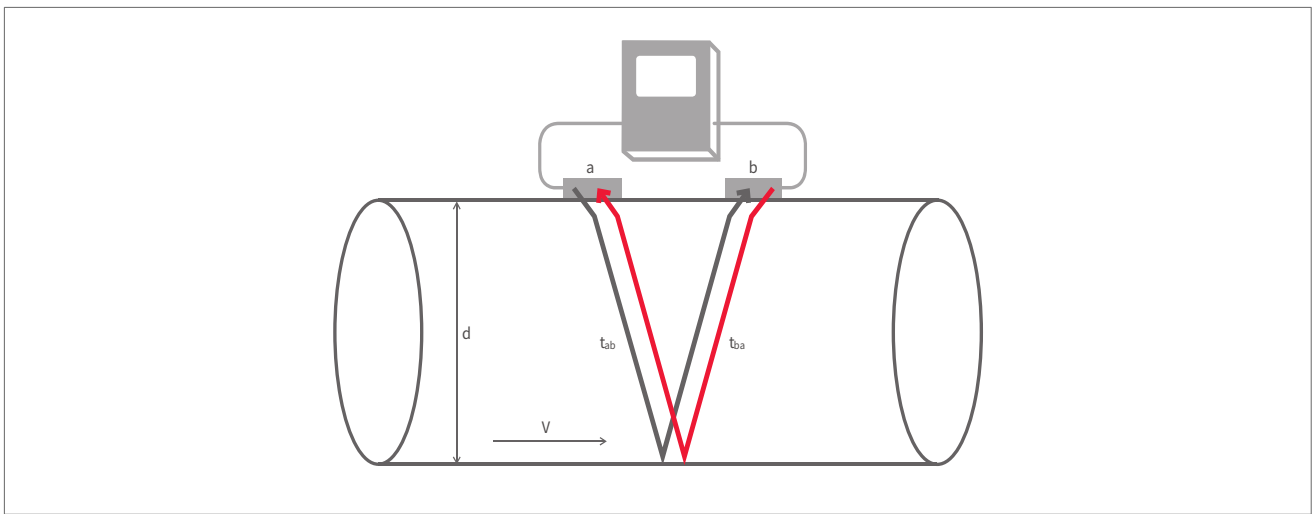

Picture 1: Clamp-on ultrasonic flowmeter configuration

2.2 Measuring principle

Ultrasonic signals are emitted by a transducer installed on a pipe and received by a second transducer. These signals are emitted alternately in the direction of flow and against it. Because the medium is flowing, the transit time of the sound signals propagating in the direction of flow is shorter than the transit time of the signal propagating against the direction of flow. The transit-time difference Δt is measured and allows the determination of the average flow velocity along the path of acoustic propagation. A profile correction is then performed to obtain the average flow velocity over the cross-sectional area of the pipe, which is proportional to the volumetric flow rate.

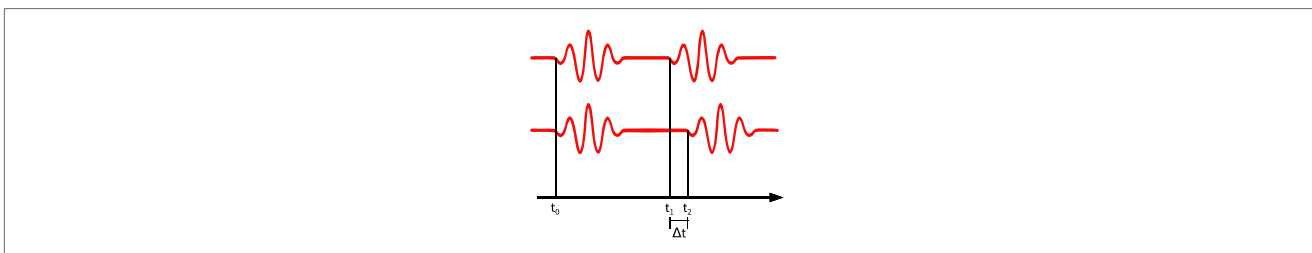

Picture 2: Transit-time measuring principle

2.3 Approvals

2.3.1 Clamp-on ultrasonic sensors

The clamp-on ultrasonic sensors are manufactured according to European Directive 2014/34/EU. This equipment has been approved for installation and use in hazardous classified areas of Zone 1 and 2 by the certification agency Element Materials Technology Rotterdam BV (ATEX notified body identification 2812). The protection method for the sensors is “encapsulation” as per EN/IEC 60079-18.

The K1Ex, K4Ex transducers meet the requirements of the following standards:

Standard	Description
EN IEC 60079-0:2018	Electrical equipment for use in explosive atmosphere – General requirements
EN 60079-18:2015/A1:2017 IEC 60079-18:2014	Electrical equipment for use in explosive atmosphere – Encapsulation “maD, mbD”
EN 60079-31:2014 IEC 60079-31:2013	Electrical equipment for use in the presence of combustible dust – Protection by enclosures “tD”



Certificate number of the K1Ex and K4Ex sensors:

TRAC09ATEX21226X

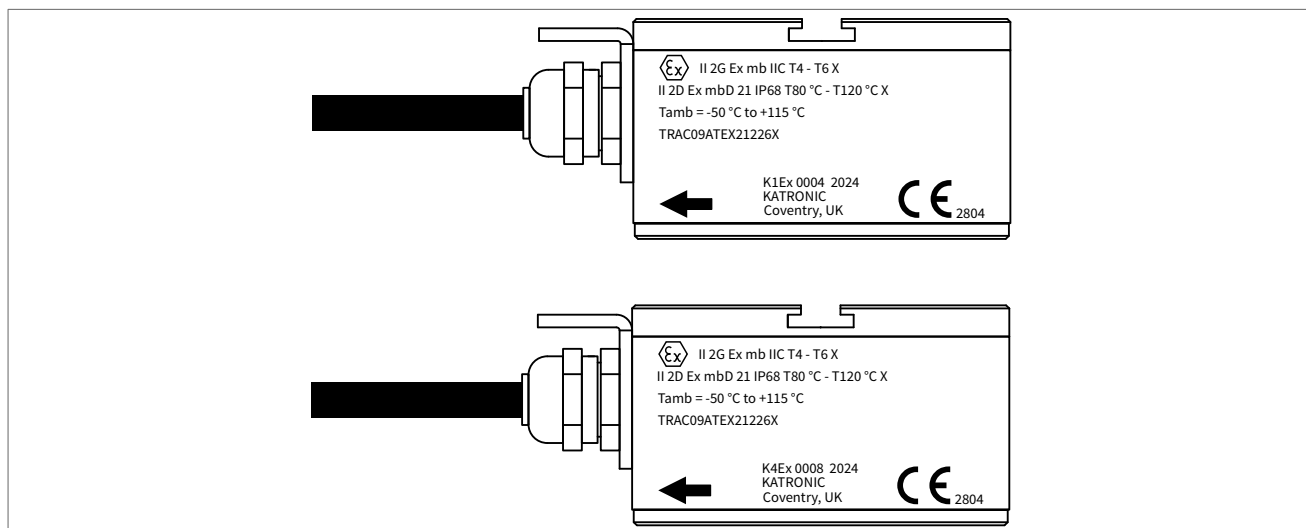

Picture 3: Rating plate sensors K1Ex and K4Ex

KATflow 170

INTRODUCTION





2.3.2 Flowmeter

The KATflow 170 flowmeter is available in epoxy-coated aluminium or in stainless steel. Both versions are certified for use in hazardous area Zone 1 or 2. K1Ex and K4Ex sensors are connected to the KATflow 170 either directly or through an Ex e certified junction box with cables provided by Katronic. The protection method for the KATflow 170 is “explosion-proof” Ex d and “increased safety” Ex e as per the following standards:

Standard	Description
EN IEC 60079-0:2018	Electrical equipment for use in explosive atmosphere – General requirements
EN 60079-1:2014	Electrical equipment for use in explosive atmosphere – Flameproof “d”
EN IEC 60079-7:2015/A1:2018	Electrical equipment for use in explosive atmosphere – Increased safety “e”
EN 60079-31:2014 IEC 60079-31:2013	Electrical equipment for use in the presence of combustible dust – Protection by enclosures “tD”



Certificate of the KATflow 170 flowmeter: IBExU17ATEX1001X (ATEX)
IECEX IBE 17.0001X (IECEX)
Certification coding: II 2G Ex db eb IIC T6 Gb

 Katronic AG & Co. KG, Gießergeweg 5, 38855 Wernigerode, Germany www.katronic.com	ULTRASONIC FLOWMETER KATflow 170 Serial Number: 17024001 Year of Manufacture: 2024 Power Supply: 100 ... 240 V AC, 50/60 Hz** Degree of Protection: IP66 Ambient Temperature: $-20\text{ °C} < T_{\text{amb.}} < +60\text{ °C}$ IBExU17ATEX1001X IECEX IBE 17.0001X    II 2G Ex db eb IIC T6 Gb 2804 2585	WARNING – DO NOT OPEN WHILE VOLTAGE IS APPLIED WARNUNG – NICHT UNTER SPANNUNG ÖFFNEN
--	--	---

Picture 4: Rating plate KATflow 170

2.4 Temperature limits

2.4.1 Clamp-on ultrasonic sensors

The K1Ex and K4Ex clamp-on ultrasonic sensors can be used for the following process temperatures depending on the temperature class specified for the application (see Table 1):

Gas groups	
Temperature class	Process temperature range
T6	-50 ... +75 °C
T5	-50 ... +90 °C
T4	-50 ... +115 °C
Dust groups	
	The ambient temperature is the limiting factor but cannot exceed +115 °C therefore the maximum temperature designation is T80 °C - T120 °C.

Table 1: Temperature class K1Ex and K4Ex sensors

2.4.2 Flowmeter

For KATflow 170 flowmeters located in Zone 1 or 2 hazardous areas the ambient temperature range is -20 ... +60 °C. The unit is manufactured to a degree of protection of IP66 (see Picture 4).

KATflow 170

INTRODUCTION

2.5 Special conditions of safe use

Flowmeter KATflow 170

- Repairs of the flameproof joints must be made in compliance with the constructive specifications provided by the manufacturer. A repair according to IEC 60079-1, Table 2 and 3 is not permitted.
- Equipment with damaged glass plate has to be taken out of operation immediately.
- Unneeded openings for cable entries have to be closed durably with suitable plugs which comply with the requirements with the corresponding type of protection and the required category.

K1Ex and K4Ex sensors:



- The transducers must only be used in conjunction with a flowmeter unit (e. g. KATflow 170) which conforms to the signal parameters and thermal protection conditions as outlined in the special conditions of safe use.
- The transducers must be securely fixed to the pipe to protect the PEEK surface of the sensors from mechanical impact and electrostatic charging.
- Where the connecting cable may be subject to mechanical damage then the user shall provide additional mechanical protection.
- Clause 10, EN 60079-18: The pulsed supply to the transducers must not exceed 330 V at a maximum frequency of 4 MHz (met by KATflow 170 electronics).

2.6 EU type examination certificates

See ATEX documentation pack.

3 INSTALLATION

3.1 Unpacking and storage

3.1.1 Unpacking

Care should be taken when opening the box containing the flowmeter, any markings or warnings shown on the packaging should be observed prior to opening. The following steps should then be taken:

- Unpack the flowmeter in a dry area.
- The flowmeter should be handled with care and not left in an area where it could be subject to physical shocks.
- If using a knife to remove packaging care should be taken not to damage the flowmeter or cables.
- The flowmeter package and contents should be checked against the delivery note supplied and any missing items reported immediately.
- The flowmeter package and contents should be checked for signs of damage during transport and any problems reported immediately.
- The vendor accepts no responsibility for damage or injury caused during the unpacking of the instrumentation supplied.
- Excess packing materials should be either recycled or disposed of in a suitable way.

3.1.2 Storage

If storage is necessary, the flowmeter and sensors should be stored:

- in a secure location,
- away from water and harsh environmental conditions,
- in such a way as to avoid damage,
- small items should be kept together in the bags and small plastic boxes provided to avoid loss.

3.1.3 Identification of components

The following items are typically supplied (please refer to your delivery note for a detailed description):

- KATflow 170 ultrasonic flowmeter,
- Clamp-on sensors (one pair for single-channel operation, two pairs for dual-channel operation),

KATflow 170

INSTALLATION

- Ex e junction box if not direct sensor connection (one junction box for single-channel operation, two junction boxes for dual-channel operation),
- Sensor connection cable(s) if not direct sensor connection,
- Sensor mounting accessories,
- Coupling component,
- Operating instructions,
- Project and hazardous area documentation,
- Calibration certificate(s) (optional).

3.2 System configuration



The KATflow 170 flowmeter and K1Ex and/or K4Ex sensors can be installed in Zone 1 or 2 hazardous areas with or without a certified optional junction box depending on the required cable distances.

A maximum of two sensor pairs can be installed - if two pairs are installed these can be configured either in a one-pipe dual-path (see Picture 5) or a two-pipe single-path (see Picture 6) configuration.

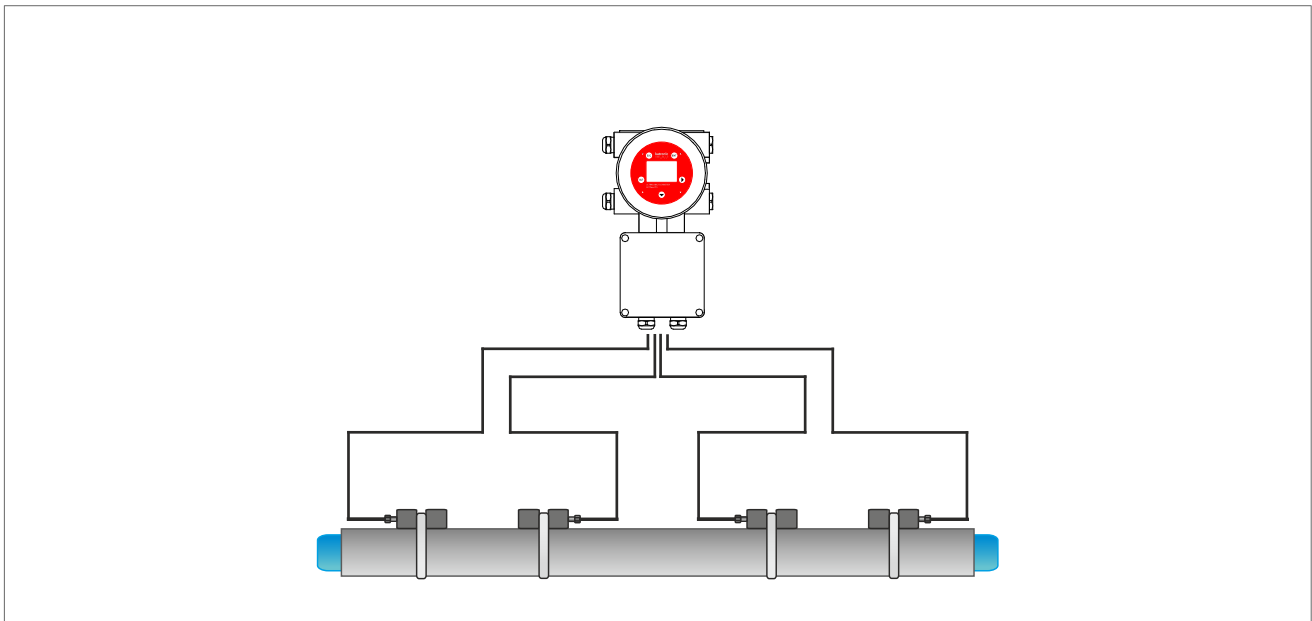

Picture 5: KATflow 170 with direct sensor connection in a 1-pipe 2-path configuration

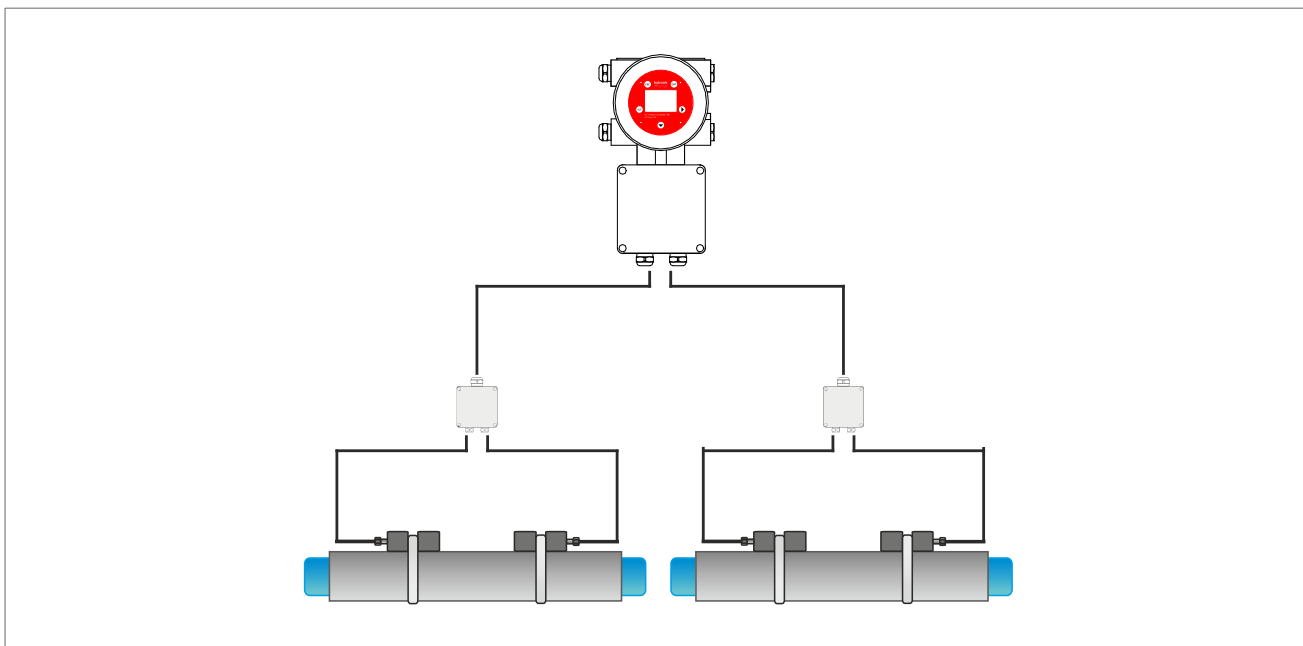

Picture 6: KATflow 170 in a 2-pipe 1-path configuration using optional junction boxes

3.3 Clamp-on sensor installation

The correct selection of the sensor location is crucial for achieving reliable measurements and high accuracy. Measurement must take place on a pipe in which sound can propagate (see Section 3.3.1 Acoustic propagation) and in which a rotationally symmetrical flow profile is fully developed (see Section 3.3.2 Straight pipe lengths).

The correct positioning of the transducers is an essential condition for error-free measurements. It ensures that the sound signal will be received under optimal conditions and evaluated correctly. Because of the variety of applications and the different factors influencing the measurement, there can be no standard solution for the positioning of the transducers.

The correct position of the transducers will be influenced by the following factors:

- diameter, material, lining, wall thickness and general condition of the pipe,
- the medium flowing in the pipe,
- the presence of gas bubbles and solid particles in the medium.

After the sensor location has been selected, make sure that the supplied cable is long enough to reach the flowmeter mounting location.



Check that the temperature at the selected location is within the operating temperature range of the transducers (see Chapter 10).

3.3.1 Acoustic propagation

Acoustic propagation is achieved when the flowmeter is able to receive sufficient signal from the transmitted ultrasonic pulses. The signals are attenuated in the pipe material, the medium and at each of the interfaces and reflections. External and internal pipe corrosion, solid particles and gas content in the medium contribute heavily to signal attenuation.

KATflow 170

INSTALLATION

3.3.2 Straight pipe lengths

Sufficient straight lengths of pipe on the inlet and outlet of the measuring location ensure an axi-symmetrical flow profile in the pipe, which is required for good measurement accuracy. If insufficient straight lengths of pipe are available for your application measurements are still obtainable, but the certainty of the measurement can be reduced.

3.4 Installation location

Select an installation location following the recommendations in Table 2 and try to avoid measuring:



- in the vicinity of deformations and defects of the pipe,
- near welding seams,
- where deposits could be building up in the pipe.

<p>For a horizontal pipe: Select a location where the transducers can be mounted on the side of the pipe, so that the sound waves emitted by the transducers propagate horizontally in the pipe. In this way, the solid particles deposited on the bottom of the pipe and the gas pockets developing at the top will not influence the propagation of the signal.</p>	
<p>For a free inlet or outlet pipe section: Select the measuring point at a location where the pipe cannot run empty.</p>	
<p>For a vertical pipe: Select the measuring point at a location where the liquid flows upward to ensure that the pipe is completely filled.</p>	

Table 2: Recommendations for sensor mounting location



Look for a sensor installation location with sufficient straight pipe to obtain accurate measurements. Please refer to Table 3 as a guideline for recommended distances from disturbance sources.

Disturbance source: 90°-elbow Inlet $L \geq 10D$	Outlet $L \geq 5D$
Disturbance source: 2 x 90°-elbow in one plane Inlet $L \geq 25D$	Outlet $L \geq 5D$
Disturbance source: 2 x 90°-elbow in different planes Inlet $L \geq 40D$	Outlet $L \geq 5D$
Disturbance source: T-section Inlet $L \geq 50D$	Outlet $L \geq 10D$
Disturbance source: diffuser Inlet $L \geq 30D$	Outlet $L \geq 5D$

KATflow 170

INSTALLATION

Disturbance source: reducer Inlet $L \geq 10D$	Outlet $L \geq 5D$
	
Disturbance source: valve Inlet $L \geq 40D$	Outlet $L \geq 10D$
	
Disturbance source: pump Inlet $L \geq 50D$	
	

Table 3: Recommended distances from disturbance sources

3.5 Pipe preparation

- Clean dirt and dust from around the area of the pipework where the sensors are to be placed.

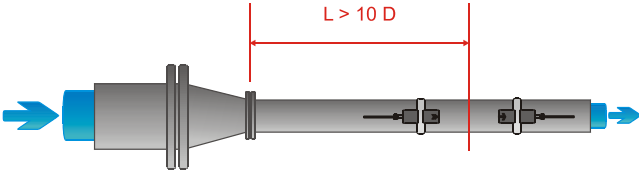
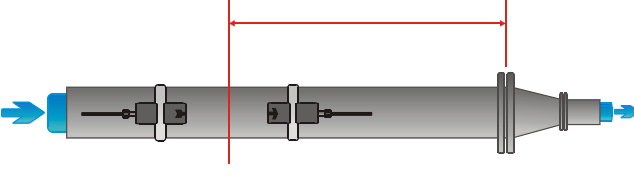
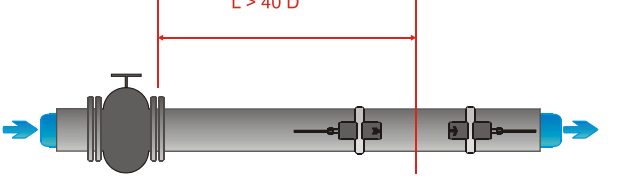
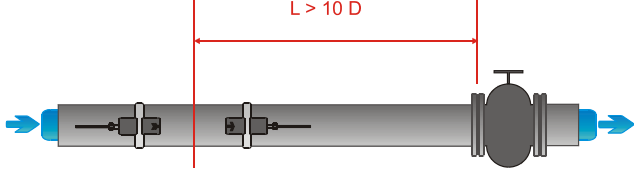
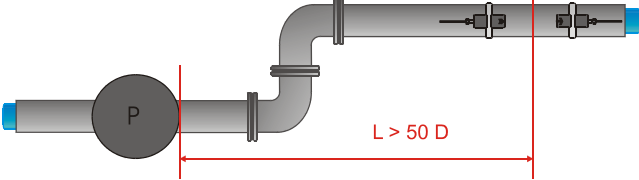

- Remove loose paint and rust with a wire brush or file.
- Firmly bonded paint does not necessarily need to be removed provided the flowmeter diagnostics indicate sufficient signal strength.

3.6 Sensor mounting configurations and separation distance

3.6.1 Reflection Mode

The most common clamp-on sensor mounting configuration is the Reflection Mode, sometimes known as V-Mode (see Picture 7, sketch 1). Here, the ultrasonic signal passes twice through the medium (two signal passes). The Reflection Mode is the most convenient mounting method as the transducer separation distance can be measured easily and the sensors can be accurately aligned. This method should be used whenever possible.

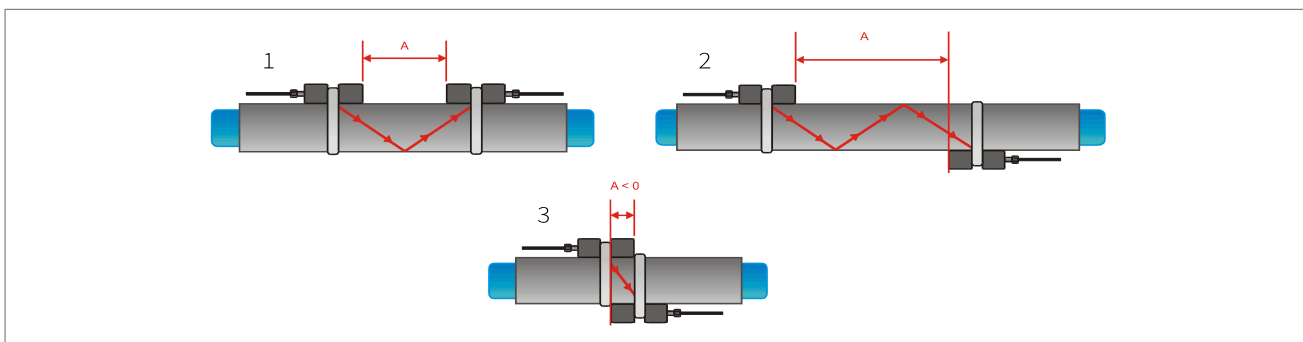

Picture 7: Clamp-on sensor mounting configurations and sensor spacing

3.6.2 Diagonal Mode

An alternative mounting configuration (see Picture 7, sketch 3) is the Diagonal Mode (Z-Mode). The signals travel only once through the pipe. This method is often used for larger pipes where greater signal attenuation might occur.

Further variation of the Reflection and the Diagonal Modes are possible by altering the number of passes through the pipe. Any even number of passes will require mounting the sensors on the same side of the pipe, while with an odd number of passes, the sensors must be mounted on opposite sides of the pipe. Commonly, for very small pipes, sensor mounting configurations such as four passes (W-Mode) or three passes (N-Mode) are used (see Picture 7, sketch 2).

3.6.3 Transducer separation distance

The transducer separation distance A is measured from the inside edges of the sensor heads as shown (see Picture 7). It is automatically calculated by the flowmeter based on the parameter entries for pipe outside diameter, wall thickness, lining material and thickness, medium, process temperature, the sensor type and the selected number of signal passes.



A negative separation distance $A < 0$ can occur for mounting configurations on small pipes where Diagonal Mode operation has been selected (see Picture 7, sketch 3). Negative separation distances may be suggested for Reflection Mode installations, but are not possible. In these cases, use Diagonal Mode or a larger number of passes.

KATflow 170

INSTALLATION

3.7 Sensor installation in hazardous areas

Before the sensors can be mounted

- the installation location should have been determined,
- a sensor mounting method should be chosen,
- the flowmeter must be mechanically and electrically installed,
- the sensors must be connected to the transmitter.

Depending on which sensor mounting method is being used, the clamp-on sensors are either mounted on the same side of the pipe (Reflection Mode) or on opposite sides of the pipe (Diagonal Mode). The sensor spacing is calculated by the flowmeter from the pipe parameters entered (see Section 3.6).



The transducers must be securely fixed to the pipe to protect the PEEK surface of the sensors from mechanical impact and electrostatic charging.

3.7.1 Acoustic coupling gel



In order to obtain acoustical contact between the pipe and the sensors, apply a bead of acoustic coupling gel lengthwise down the centre of the contact area of the sensors.



Picture 8: Application of acoustic coupling gel

3.7.2 Correct positioning of the sensors

Always mount the transducer pair so that the free front edges of the sensors face each other. There is a different engraving on the top of each transducer. The transducers are mounted correctly if the engravings on the two transducers form an arrow. The transducer cables should point in opposite directions. Later, the arrow, in conjunction with the indicated measured value, will help to determine the direction of flow (see Section 3.4).

The sensor separation distance is automatically calculated by the flowmeter based on the parameter entries for pipe outside diameter, wall thickness, lining material and thickness, medium, process temperature, the sensor type and the selected number of signal passes. The sensor positioning screen (see Section 5.3) allows fine adjustment of the sensor location.



Picture 9: Correct positioning of the sensors

KATflow 170

INSTALLATION

3.7.3 Sensor mounting with tension straps

- Cut the tension straps to the appropriate length.
- Pull at least 2 cm of the tension strap through the slot in the clamp and bend the strap back to secure the clamp to the tension strap.
- Guide the other end of the tension strap through the groove on top of the sensor.
- Place the sensor onto the prepared pipe section.
- Hold the transducer with one hand and guide the tension strap around the pipe.
- Pull the tension strap and guide the free end through the clamp so that the clamp hooks engage. Slightly tighten the screw on the clamp.
- Mount the second sensor in the same way.
- Press the sensors firmly onto the pipe. There should be no air pockets between the transducer surface and the pipe wall.
- Using a measuring tape, adjust the sensor separation distance as suggested by the flowmeter. When the sensor positioning screen is displayed (see Section 5.3), the middle bar allows fine adjustment of the sensor location.
- Ensure that the narrower side of the clip is above and inside the wider side and that the two sides of the clip do not come into contact while tightening, as this will prevent the strap from being correctly tensioned.



Picture 10: Metallic mounting straps

3.8 Flowmeter installation in hazardous areas

The KATflow 170 is intended for 2" mounting pole installations as shown in the following picture. Wall mounting is also possible but requires an optional bracket.



Picture 11: K1Ex/K4Ex transducer and KATflow 170

KATflow 170

INSTALLATION

3.9 Flowmeter installation

3.9.1 Outline dimensions

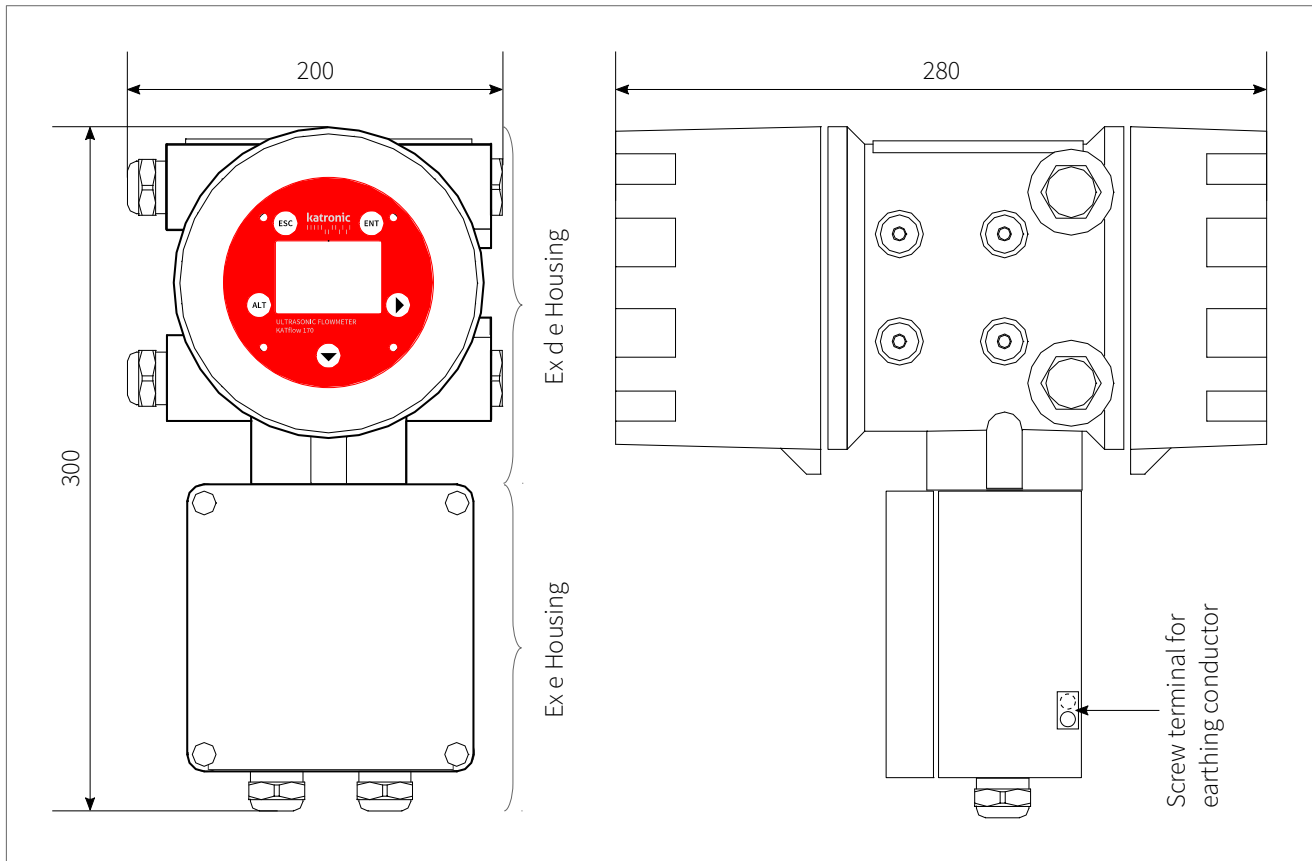

Picture 12: Outline dimensions KATflow 170

4 ELECTRICAL INSTALLATION

4.1 Electrical wiring

The wiring of the equipment must be in accordance with the requirements as specified in the relevant national or international standard for electrical installations in hazardous areas, e. g. EN/IEC 60079-14. Section 9 (wiring systems) of this standard applies to all protection concepts, Section 10 covers additional requirements for protection concept “d” - explosion-proof enclosures and Section 11 covers additional requirements for protection concept “e” - increased safety.



Please note that in order to supply the unit with mains power, the equipment must be protected by suitably sized switches and circuit breakers.

100 ... 200 V AC, 50/60 Hz

10 VA

9 ... 36 V DC

10 W

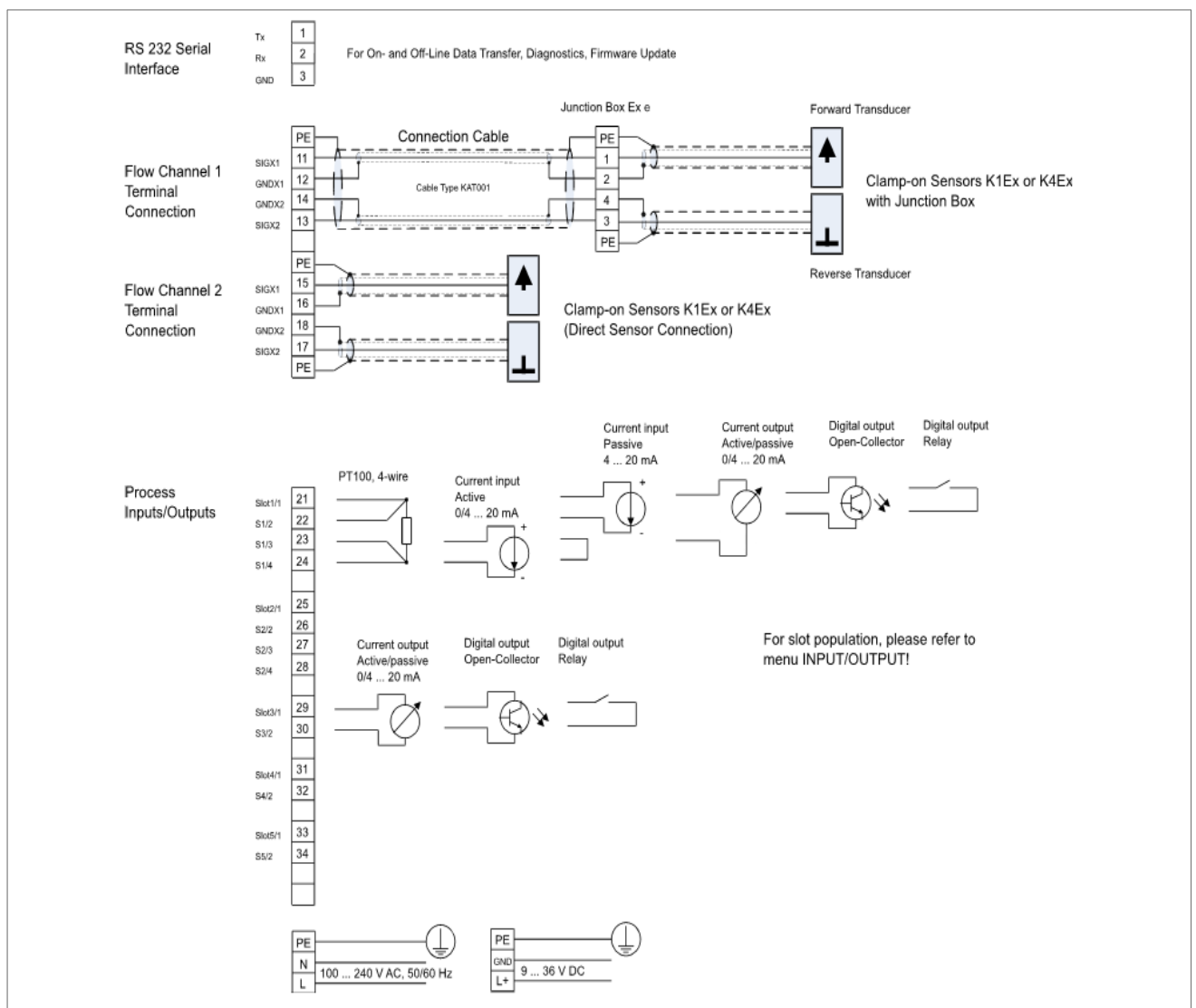

Picture 13: Electrical connection diagram for the KATflow 170 flowmeter

KATflow 170

ELECTRICAL INSTALLATION

4.2 Cabling and junction box

The hazardous area K1Ex and K4Ex sensors are manufactured with a standard cable length of 5 m. If this cable length is sufficient for the application, then the sensors can be connected directly to the flowmeter (direct cable connection).



For installations requiring longer cable lengths, the sensors are terminated at an Ex e (increased safety) certified junction box with approved terminals.

The electrical connection between the junction box and the flowmeter (signal cabling) is established using type KAT01 dual coax cable. The cable ends of the coaxial cables must be appropriately terminated with tinned ends or suitably sized ferrules. The signal cable is provided with the system. The maximum recommended signal cable length is 100 m.

4.2.1 Signal cable parameters

The signal cable supplied with the instrument has the following parameters (Table 4):

Total attenuation	0.021 dB/m
Capacitance (core/screen)	107 pF/m
Inductance (core/screen)	0.24 µH/m

Table 4: Signal cable parameters



Where the connecting sensor and/or signal cable may be subject to mechanical damage then the user shall provide additional mechanical protection.

4.3 Cable glands

The KATflow 170 housing features 2 x M20 cable entries for the sensor cabling (Ex e housing, square part of the housing, see Picture 12 and Table 5 for installation location) and 4 x M20 cable entries for power supply, communication and process input/output connections (Ex de housing, round part of the housing).

The KATflow 170 housing is supplied with plastic dust caps. The temporary plugs are only intended for sealing the equipment against entry of dust, moisture or other possible ingress during transport, handling and storage. These dust caps must be replaced by suitable Ex e approved cable glands, stopping plugs or conduit adapters with respective sealing before the flowmeter is put into operation. The installer is responsible for the correct sizing and selection of the Ex e approved cable glands for the explosion-proof box. Unused cable entries must be closed with suitable Ex e blind plugs. Ex e approved cable glands/blind plugs are not part of the standard delivery package and must be provided by the customer or explicitly ordered from Katronic.

The following Ex e cable glands are available from Katronic:

Cable gland	Cable diameter	Cable type	Installation location	Possible number of pieces
M20	10 ... 14 mm	Power, communication, process input/output	Ex de housing	4
M20	7 ... 12 mm	Power, communication, process input/output	Ex de housing	4
M20	2 x 6 mm	K1Ex, K4Ex direct sensor connection	Ex e housing	2
M20	12 mm	System cable KAT01 from junction box	Ex e housing	2
M20	Blind plug		Ex de + Ex e housing	6

Table 5: Overview installation location and possible number of Ex e cable glands

4.4 Equipotential bonding

4.4.1 Clamp-on ultrasonic sensors



The K1Ex and K4Ex sensors feature a terminal connection which must be used to connect the transducers to the equipotential bonding system locally.

4.4.2 Flowmeter



The KATflow 170 flowmeter must always be incorporated in the equipotential bonding system of the hazardous area installation. The explosion-proof housing of the KATflow 170 features a screw terminal outside the housing, which must be earthed locally (see Picture 12). The earthing conductor must have at least a cross-sectional area of 4 mm² (11 AWG).

The protective earth conductor inside the housing to be connected to the earth terminal marked PE must have at least the same cross-sectional area as the line conductor to be connected to the terminal marked L1 (see Picture 13).

4.5 Process inputs/outputs



If the process inputs/outputs are to be terminated in the hazardous area, the associated equipment must be certified accordingly.

KATflow 170

OPERATION

5 OPERATION

5.1 Switching On/Off

The flowmeter is switched on by connecting the power supply to the instrument. Disconnecting the external supply switches the flowmeter off.

5.2 Keypad and display

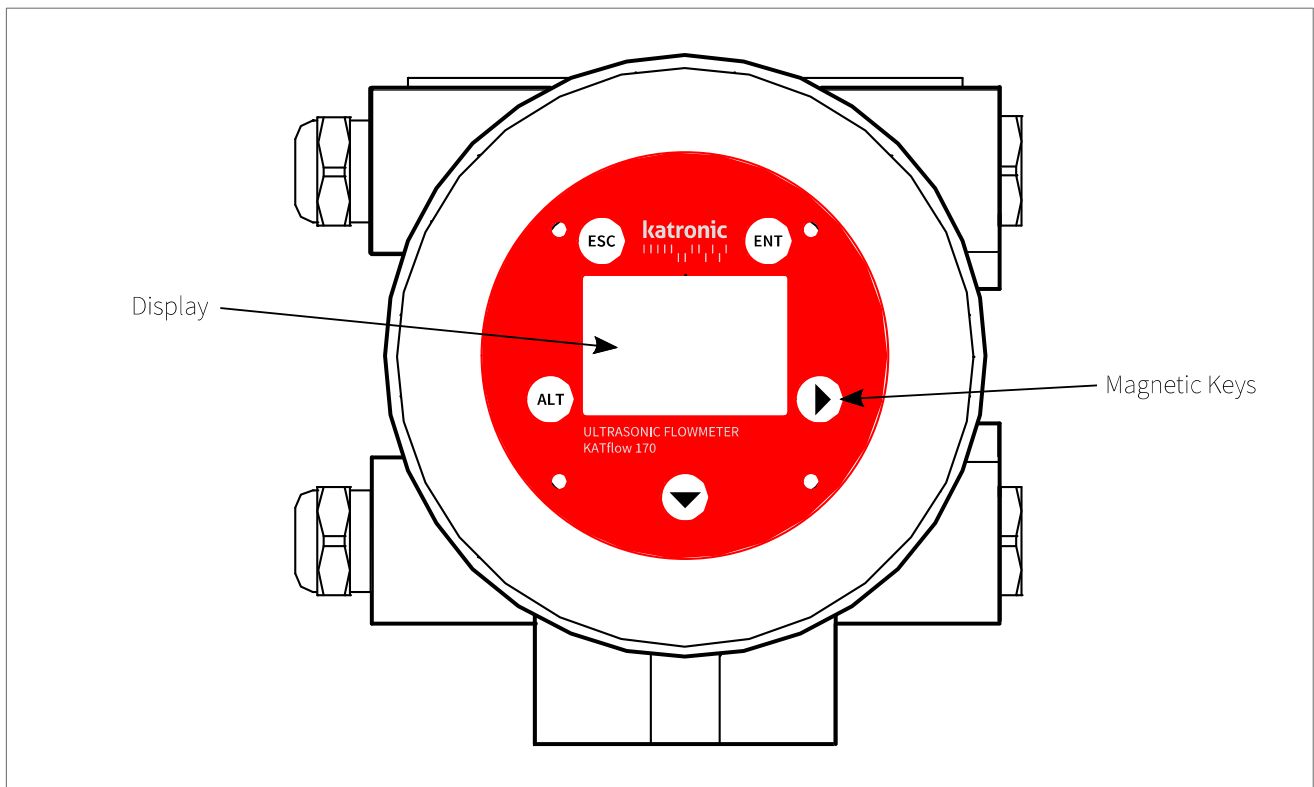

Picture 14: Keypad and display KATflow 170

The keypad of the KATflow 170 consists of five magnetic keys which can be operated from the outside of the enclosure using a magnetic pen. Hold the pen against the key area (white circle). The instrument acknowledges the activation of the key by turning the backlight off for a fraction of a second.



Customer-specific settings for data to be displayed can be achieved by using the appropriate menu items.

5.2.1 Keypad key functions





Used keys	Main function	Secondary function
	Character position selection for data entry Move RIGHT	In menus: Contrast adjust on main menu (if key currently has no other function) Position/character selection for data entry In measurement mode: Switches between process value display and diagnostic display
	Move menu/list selection item DOWN	Move in scrolled lists Character entry from scrolled characters In measurement mode: Screen selection
	Backlight on/off	In menus: Backlight on/off 4 x ALT opens quick access to device functions A code can be used to switch directly to important device functions. Codes: 1: Keypad sound off/on, 2: Language selection, 5: Scope function Character entry: Delete character at current cursor pos. In measurement mode: Switch between the channels
	ESC ape menu item	Abort entry without saving In measurement mode: Escape measurement mode
	ENT er menu item	Confirm and save entry or move through menu structure In diagnostic and scope display: Switches between measured values of the flow directions (upstream - against flow direction (U) and downstream - in flow direction (D)) Standard is U (Note: The switching function applies to ultrasonic board version 5.0 or higher)

Table 6: Keypad key functions

KATflow 170

OPERATION

5.2.2 Display icons and functions

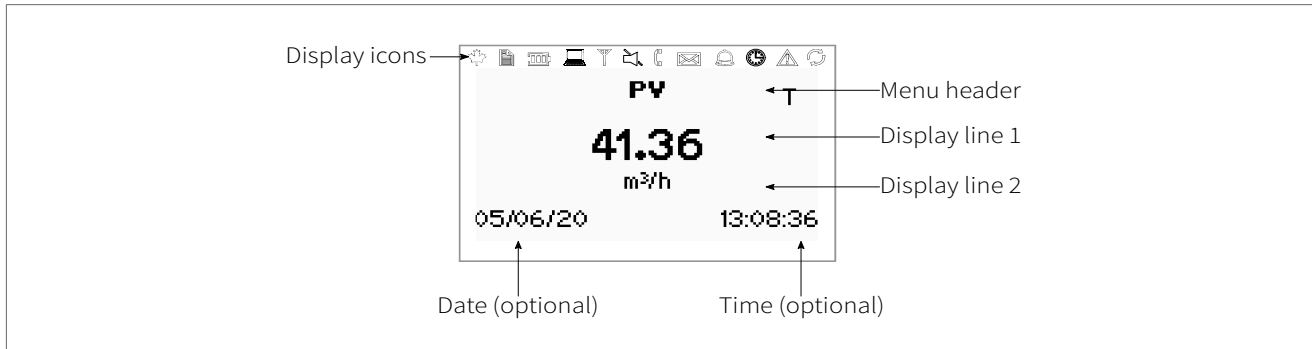

Picture 15: Display overview

Display icon	Function	
	On Off Flashing	Display of the transmission voltage: 75 V 10 V 150 V
	On Off Flashing	Data logger recording Data logger switched off Data logger almost full
		Function not used on KATflow 170
	On Off	LCD backlight switched on LCD backlight switched off
	On Off	I/O processor error (internal display only) I/O processor works without errors
	On Off	Without strike-through: Speaker on With strike-through: Speaker off
	On Off	Coupling error Sensor operating correctly
		Function not used on KATflow 170
	On Off	Key lock activated Key lock deactivated
	On Off	Time/date set (where specified) Clock error
	On Off	Error recorded in error log No error detected
	On Off	Serial communication on (where specified) Serial communication off
L, T or LT		Displays whether flow is Laminar, Turbulent or Laminar-Turbulent
Q	On Off	Totaliser for the active channel switched on Totaliser for the active channel switched off

Table 7: Display icon functions

5.3 Quick Setup Wizard

The Quick Setup Wizard allows for a speedy setup of the most important parameters in order to achieve successful measurements in the shortest possible time:



Applying the magnetic pen can be considered pressing a key.

Used keys	Display screen	Operation
		At first power on and the boot sequence, the “Main Menu” is displayed. Use the DOWN key to select “Quick Start” and confirm by pressing ENTER .
		Use DOWN key to select “Setup Wizard”. Confirm by pressing ENTER . If the sensors are recognised, the serial number will be shown. If not, the type can be selected.
		Select the main measurement unit using the DOWN and RIGHT keys and confirm with ENTER . This unit will be displayed in the middle of the measurement screen.
		Select the fluid using the DOWN and RIGHT keys. Confirm by pressing ENTER .
		Enter the fluid temperature using DOWN and RIGHT keys and confirm with ENTER . Use RIGHT key to character position selection for correcting entry errors.
		Select pipe material using the DOWN and RIGHT keys and confirm with ENTER .
		Enter the outer pipe diameter using DOWN and RIGHT keys confirm with ENTER . Use RIGHT key to character position selection for correcting entry errors. If 0 is entered and confirmed, an additional screen appears that allows entry of the circumference. Press ALT to delete characters at the current cursor position.

KATflow 170

OPERATION







Used keys	Display screen	Operation
	<p>PIPE CIRCUMFERENCE</p> <p>0.0 mm</p> <p>CH1</p>	Enter the circumference using DOWN ▼ and RIGHT ► keys and confirm with ENTER .
	<p>WALL THICKNESS</p> <p>3.6 mm</p> <p>CH1</p>	Enter pipe wall thickness using DOWN ▼ and RIGHT ► keys and confirm with ENTER . Use RIGHT ► key to character position selection for correcting entry errors.
	<p>LINER MATERIAL</p> <p>None Epoxy Rubber</p> <p>CH1</p>	Select pipe liner material using DOWN ▼ and RIGHT ► keys. Confirm by pressing ENTER . If a liner material is chosen, an additional screen appears that allows entry of liner thickness.
	<p>PASSES</p> <p>1 2 3</p> <p>CH1</p>	Select number of sound passes (sound paths) using DOWN ▼ and RIGHT ► keys. Auto: Automatically 1: 1 pass (Diagonal Mode) 2: 2 passes (Reflection Mode) 3: 3 passes (Diagonal Mode) 4: 4 passes (Reflection Mode) etc. Confirm with ENTER .
	<p>QUICK START</p> <p>Setup Wizard CH1 Setup Wizard CH2 Start Measurement Totaliser</p>	Select "Start Measurement" and confirm with ENTER to start the sensor positioning procedure.
	<p>SENSOR CH1</p> <p>Spacing +113.6 mm Passes 4 Signal +49.5 dB</p> 	<p>Sensor positioning screen: Mount transducers with suggested spacing and use middle bar for fine adjustment of position (central position is desired). Observe signal-to-noise (upper bar) and quality (lower bar). These should be of identical length. ALT activates the scope function for further diagnosis. ► switches between different signal diagnostic data. Confirm by pressing ENTER to obtain measurements. Note: Numbers shown are for indication only.</p>
	<p>PV CH1 T</p> <p>42.20 m³/h</p> <p>06/02/24 12:35:33</p>	Success!

Table 8: Quick Setup Wizard

5.4 Measurement

5.4.1 Main process value display

Measurement is started using “Start Measurement” in the Quick Start Wizard. If all parameters have been entered, the next time the flowmeter is switched on the main process value (PV) is immediately shown on the display and/or made available as an output signal (if installed and operating).



The main process value (PV) is the primary measurement data and is usually displayed as the middle unit. User-specific settings for the main process value display can be made using the corresponding options in the menu. The process value can be selected from a list of available values.

Used keys	Display screen	Operation
		<p>The main process value can be changed in the “Quick Start” or “Installation” menus. Press ESC at any time to return to the main menu.</p> <p>Change to the diagnostic display by pressing RIGHT and DOWN .</p> <p>With ALT it is possible to switch between channel 1 and channel 2 in a dual-channel flowmeter.</p>

Table 9: Main process value display



The sequence of the process value displays is: Main process value display, three-line display, totaliser display, dual-channel display, “Math” display.

5.4.2 Three-line display

Used keys	Display screen	Operation
		<p>The three-line display screen is configurable to show flow, totalisers and diagnostic functions.</p> <p>Change to other measurement and diagnostic displays by pressing the RIGHT and DOWN keys.</p>

Table 10: Main process value display in three-line display format

5.4.3 Totaliser



The totaliser displays will only be shown when the totalisers are activated and a volume flow, mass flow or heat flow is selected as process value (middle line).

KATflow 170

OPERATION

Used keys	Display screen	Operation
	<pre> Q PV CH1 T (Q+) 2.55 m³ 42.40 m³/h (Q-) 0.00 m³ 06/02/24 12:43:34 </pre>	<p>The flow totaliser can be started or reset by selecting “Totaliser” from the main menu. The totaliser can be viewed on the three-line display as shown, or by selecting a quantity as the middle unit.</p> <p>View the three-line menu by pressing the DOWN ▼ button.</p>

Table 11: Totaliser display

5.4.4 Diagnostic display

Used keys	Display screen	Operation
	<pre> DIAGNOSTICS CH1 27.9 dB Gain 36.7 dB Signal (US) -10.1 dB Noise 06/02/24 12:44:49 </pre>	<p>Line 1 shows the amplifier gain. Line 2 displays the signal strength. Line 3 indicates the noise.</p> <p>Change to more diagnostic displays by pressing DOWN ▼.</p> <p>Cycle through available flow channels using ALT if two channels are activated. ENTER changes between signal strength in flow direction (D) and against flow direction (U) (Note: This applies to ultrasonic board version 5.0 or higher).</p> <p>Refer to Customer Support for the meanings of each diagnostic screen.</p>

Table 12: Diagnostic display



Diagnostic displays can be viewed directly during measurement. Other diagnostic functions are available in the menu structure.

5.4.5 Dual-channel measurement screen

Used keys	Display screen	Operation
	<pre> DUAL CH1 T CH1 42.64 m³/h m³/h CH2 42.61 m³/h 06/02/24 13:01:32 </pre>	<p>Line 1 shows the PV on the selected channel. Line 2 shows the selected units. Line 3 shows the PV on the other channel (in its selected units)</p> <p>Change to other measurement and diagnostic screens by pressing the RIGHT ► and DOWN ▼ keys.</p>

Table 13: Dual-channel measurement screen



The dual-channel measurement screen is skipped if the flowmeter is not configured as a dual-channel device or if one of the channels is disabled.

5.4.6 “Math” display

Used keys	Display screen	Operation
		<p>Displays the “Math” function (when enabled on multi-channel meters). “Sum”, “Difference”, “Average” and “Maximum” can be selected in the “Calculation” menu. “Average” shown in illustration. Change to other measurement and diagnostic screens by pressing the RIGHT ▶ and DOWN ▼ keys. Cycle through available flow channels using ALT if two channels are activated.</p>

Table 14: “Math” display



The same units must be set for the function selection “Sum”, “Difference” or “Average”. Otherwise the error message “!?!” will be displayed instead of the unit. If “Maximum” is selected as math function, the units of the channel which delivers the highest measured value is displayed (related to the set units, not m/s basic process measured value).

5.4.7 Data logger

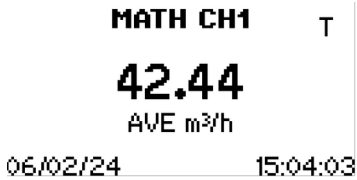
- The data logger is enabled from the “Main Menu” and operates when a non-zero value is entered for the interval.
- Items to be logged are selected from the “Selection” screen. **ENT** selects and deselects items.
- Up to ten items may be selected.
- When “dB Signal” and “dB SNR” are selected, two variables are stored, since one measurement is carried out with the flow direction (D – downstream) and one against the flow direction (U – upstream) (Note: This applies to ultrasonic board version 5.0 or higher).



- If no items are selected the logger will record blank space.
- Send logger by serial port to a terminal program by selecting “Log Download”.
- Clear the logger by selecting “Log Erase”.
- Remaining logger space can be seen in the diagnostic displays.
- Logged data can be downloaded, viewed and exported using the KATdata+ software.
- “Wrap Mode” saves as a single measurement session which deletes earlier data once the logger is full. When resuming a measurement, it must be confirmed that the data memory will be deleted in this case. If a restart occurs that is not user initiated (for example power failure), the previous measurement session will be continued. Note that KATdata+ software cannot be used with this mode.

KATflow 170

COMMISSIONING

6 COMMISSIONING

6.1 Menu structure

Main menu	Menu level 1	Menu level 2	Description/settings
Quick Start			
	Setup Wizard CH1 or CH2		Select channel 1, channel 2
		Middle Units (main displayed)	Select from list where available ↓→ <ul style="list-style-type: none"> • Off (disable channel) • m/s, ft/s, in/s (flow velocity) • m/s, ft/s, in/s, m³/h, m³/min, m³/s, l/h, l/min, l/s USgal/h, USgal/min, USgal/s, bbl/d, bbl/h, bbl/min (volume flow) • g/s, t/h, kg/h, kg/min (mass flow) • m³, l, USgal, bbl (volume, totaliser volume flow) • g, t, kg (mass, totaliser mass flow) • W, kW, MW (heat flow, HQM) • J, kJ, kWh (heat, totaliser heat flow) • m³(D), m³(M), m³(Y) (period totaliser: daily, monthly, yearly) • kg(D), kg(M), kg(Y) • J(D), J(M), J(Y) Diagnostic data: <ul style="list-style-type: none"> • dB Signal (signal), dB Noise (noise), dB SNR (signal-to-noise ratio) • m/s c (speed of sound), T CU (housing temperature) • K (correction factor), Re (Reynolds number) • V (battery voltage) • SoS (calculated speed of sound), V Sensor (sensor voltage), Density, Kin. Vis. (kinematic viscosity), Dyn. Vis. (dynamic viscosity), SHC (specific heat capacity from inputs/calculation) • T Med. (specified or measured fluid temperature) • Press. (specified or measured fluid pressure) • T_{in}, T_{out} (inlet and outlet temperature) • Other (assignable input or calculated value) • Math (calculated value – see below)
		Default Sensor	Indication of sensor type and serial number if automatically detected, otherwise select from list ↓→ <ul style="list-style-type: none"> • K1L, K1N, K1E, K1Ex, K1P • K4L, K4N, K4E, K4Ex • K0L, K0N, K2T4, M, Q, Special (see “Start Measurement” below)
		Thermobuffer (TB)	Select the type of the Thermobuffer ↓→ <ul style="list-style-type: none"> • Type 1, Type 2, Type 3 • Special TB [please refer to the dedicated documentation]

Main menu	Menu level 1	Menu level 2	Description/settings
		Fluid	Select from list ↓→ <ul style="list-style-type: none"> Water, Salt water, Acetone, Alcohol, Ammonia, Carbon Tet (carbon tetrachloride), Ethanol, Ethyl alcohol, Ethyl ether, Ethylene glycol, Glycol/water 50 %, Kerosene, Methanol, Methyl alcohol, Milk, Naphtha, Car oil, Refrigerant R134a, Refrigerant R22, Hydrochloric acid, Sour cream, Sulphuric acid, Toluene, Vinyl chloride, User (kinematic viscosity, density, medium sound speed)
		Temperature	-30 ... +300 °C
		Kinematic Viscosity	(Only if user fluid selected) 0.001 ... 30 000 mm ² /s
		Density	(Only if user fluid selected) 100 ... 2 000 kg/m ³
		Medium Sound Speed	(Only if user fluid selected) 100 ... 3 500 m/s
		Heat Capacity	(Only if user fluid selected) 0 ... 10 J/(g*K)
		Pipe Material	Select from list ↓→ <ul style="list-style-type: none"> Stainless steel, Carbon steel, Ductile cast iron, Grey cast iron, Copper, Lead, PVC, PP, PE, ABS, Glass, Cement User (pipe sound speed)
		Pipe Sound Speed	(Only if user pipe material selected) 600 ... 6 553.5 m/s
		Outside Diameter	6 ... 6 500 mm
		Circumference	(Only if 0.0 is selected for outer diameter) 18.8 ... 20 420.4 mm
		Wall Thickness	0.5 ... 80 mm
		Liner Material	Select from list ↓→ <ul style="list-style-type: none"> None Epoxy, Rubber, PVDF, PP, Glass, Cement User (liner sound speed)
		Liner Thickness	(Only if lining material selected) 1 ... 99 mm
		Passes	Select from list ↓→ Auto, 1 ... 16
	Start Measurement		
		Sensor Type	Indication of sensor type and serial number if automatically detected, otherwise select from list ↓→ (see above)
		SP1 – Sensor Frequency	Only for special, unrecognised sensors
		SP2 – Wedge Angle	Only for special, unrecognised sensors
		SP3 – Wedge Sound Speed 1	Only for special, unrecognised sensors

KATflow 170

COMMISSIONING

Main menu	Menu level 1	Menu level 2	Description/settings
		SP4 – Wedge Sound Speed 2	Only for special, unrecognised sensors
		SP5 – Crystal Offset	Only for special, unrecognised sensors
		SP6 – Spacing Offset	Only for special, unrecognised sensors
		SP7 – Zero Flow Offset	Only for special, unrecognised sensors
		SP8 – Upstream Offset	Only for special, unrecognised sensors
		Sensor K-Factor	Only for special, unrecognised sensors
		Sensor Placement	Adjust sensor position (see sensor positioning screen, Section 5.3)
	Totaliser		Select channel 1, channel 2 <ul style="list-style-type: none"> • Off, On • Reset • Reset Day, Reset Month, Reset Year
Installation			Select channel 1, channel 2
	Pipe		
		Material	Select from pipe material list ↓
		Outside Diameter	6 ... 6 500 mm (outside diameter)
		Wall Thickness	0.5 ... 80 mm (wall thickness)
		Transv. Sound Velocity	(Transverse sound velocity) 600 ... 6 553.5 m/s
		Circumference	18.8 ... 20 420.4 mm (pipe circumference)
		Roughness	0 ... 10 mm
	Medium		
		Fluid	Select from fluid list ↓
		Temperature	-30 ... +300 °C
		Kinematic Viscosity	0.001 ... 30 000 mm ² /s
		Dynamic Viscosity	0 ... 30 000 g/ms
		Density	100 ... 2 000 kg/m ³
		Transv. Sound Velocity	(Transverse sound velocity) 100 ... 3 500 m/s
		Heat capacity	0 ... 10 J/(g*K)
	Lining		
		Material	Select from material list ↓
		Thickness	1 ... 99 mm

Main menu	Menu level 1	Menu level 2	Description/settings
		Transv. Sound Velocity	(Transverse sound velocity) 600 ... 6 553 m/s
	Passes		Select from list ↓→
	Thermobuffer		Select from list ↓→
Display			Select channel 1, channel 2
	Top Line		Select units from list ↓→
	Middle Line		Select units from list ↓→
	Bottom Line		Select units from list ↓→
	Damping		Reduces fluctuations in the display output 1 ... 255 measurements
	Metric/Imperial		Use metric or imperial units for entered data
	Auto display seq.		Set automatic change of display 0 ... 60 measurements (0 deactivates automatic change of display)
Inputs/ Outputs			Lists available input/output slots Possible configurable settings below [where specified]
	Information		Shows the major input/output software version
	Test		Possibility for testing the input/output
	Reset		Reset of the input/output
I Out			Analogue current output (active or passive)
	Configure		Individual module settings
		Source	Select from list ↓→ Off, Channel 1, Channel 2, Math 1, Math 2, System
		Units	Select from list ↓→
		Min. Value	Min. process variable (PV) value that corresponds to 0 mA (only active) or 4 mA -10 000 ... 10 000
		Max. Value	Max. process variable (PV) value that corresponds to 20 mA -10 000 ... 30 000
		Damping	Additional smoothing of the current output, the higher the damping factor: 1 ... 255 measurements
		Span	(Only active current output) 0 ... 20 mA or 4 ... 20 mA
		Error	Defines output behaviour in the event of error Select from list ↓→ <ul style="list-style-type: none"> • Hold (hold last value, select hold time) • 3.8 mA • 21.0 mA • User (0 ... 24.0 mA)
Voltage Out			Analogue voltage output
	Configure		Individual module settings

KATflow 170

COMMISSIONING

Main menu	Menu level 1	Menu level 2	Description/settings
		Source	Select from list ↓→ Off, Channel 1, Channel 2, Math 1, Math 2
		Units	Select from list ↓→
		Min. Value	Min. process variable (PV) value that corresponds to 0 V -10 000 ... 10 000
		Max. Value	Max. process variable (PV) value that corresponds to 10 V -10 000 ... 30 000
		Damping	Additional smoothing of the current output, the higher the damping factor: 1 ... 255 measurements
Frequency Out			Analogue frequency output
	Configure		Individual module settings
		Source	Select from list ↓→ Off, Channel 1, Channel 2, Math 1, Math 2
		Units	Select from list ↓→
		Min. Value	Min. process variable (PV) value that corresponds to minimum frequency: -10 000 ... 10 000
		Max. Value	Max. process variable (PV) value that corresponds to maximum frequency: -10 000 ... 30 000
		Damping	Additional smoothing of the current output, the higher the damping factor: 1 ... 255 measurements
Pulse Out/ Open Col- lector			Digital open-collector output
	Configure		Individual module settings
		Source	Select from list ↓→ Off, Channel 1, Channel 2, Math 1, Math 2
		Mode	Select from list ↓→ Alarm: PV alarm switch <ul style="list-style-type: none"> On Point – Value of the process variable (PV) at which the relay switches to alarm mode: -10 000 ... 10 000 Off Point – Value of the process variable (PV) at which the relay interrupts the alarm mode again: -10 000 ... 10 000 Pulse: Sum value of the selected process variable (PV) for which a pulse signal is generated, e. g. PV [m ³], pulse value = 10, a pulse is generated every 10 m ³ <ul style="list-style-type: none"> Amount of the selected unit: 0.001 ... 1 000 000 (total of the selected unit) Width: Duration of the pulse 10 ... 999 ms Source (Grand, Positive, Negative) Linear: Calculated maximum number of pulses per second, i. e. the maximum pulse rate in Hz <ul style="list-style-type: none"> Min. Value: -10 000 ... 10 000 Max. Value: -10 000 ... 30 000 Damping: 1 ... 255 measurements

Main menu	Menu level 1	Menu level 2	Description/settings
		Units	Select from list ↓→
Relay Out			Digital relay output
	Configure		Individual module settings
		Source	Select from list ↓→ Off, Channel 1, Channel 2, Math 1, Math 2, System
		Mode	Select from list ↓→ Alarm: <ul style="list-style-type: none"> • On Point – Value of the process variable (PV) at which the relay switches to alarm mode: -10 000 ... 10 000 • Off Point – Value of the process variable (PV) at which the relay interrupts the alarm mode again: -10 000 ... 10 000 Pulse: <ul style="list-style-type: none"> • Amount of the selected unit: 0.001 ... 1 000 000 (total of the selected unit) • Width (in ms): 10 ... 999 ms Linear: <ul style="list-style-type: none"> • Min. Value: -10 000 ... 10 000 • Max. Value: -10 000 ... 30 000 • Damping: 1 ... 255 measurements
		Units	Select from list ↓→
Current In			Analogue current input
	Configure		Individual module settings
		Source (Channel)	Select from list ↓→ Off, Channel 1, Channel 2, System
		Units (Value)	Select from list ↓→ Density, Kin. Viscosity, Dyn. Viscosity, Temperature, Pressure, Other
		Min. Value	Minimum value of the variable input parameters: -10 000 ... 10 000
		Max. Value	Maximum value of the variable input parameters: -10 000 ... 30 000
		Span	0 ... 20 mA or 4 ... 20 mA
Pt 100X 4 Wire			Temperature input
	Configure		Individual module settings
		Source	Select from list ↓→ Off, Channel 1, Channel 2, System
		Type	Select from list ↓→ <ul style="list-style-type: none"> • User – Input of a temperature value defined by the user within the range -200 ... +600 °C • Pt 100 – Temperature (in °C) determined and read in by a probe (Pt 100) • Pt 1000 – Temperature (in °C) determined and read in by a probe (Pt 1000)

KATflow 170

COMMISSIONING

Main menu	Menu level 1	Menu level 2	Description/settings
		In-Out	Select from list ↓→ <ul style="list-style-type: none"> Inlet – Inlet temperature for HQM measurement Outlet – Outlet temperature for HQM measurement Compensation – Temperature for temperature compensated measurements Inlet + Comp. Outlet + Comp.
		Value	(Only if user selected) Input of a temperature value defined by the user within the range -200 ... +600 °C
		Offset	(Only if Pt 100 selected) Input of a user-defined offset within the range -100 ... +100 °C
Modbus RTU			[please refer to the dedicated documentation]
Modbus TCP			[please refer to the dedicated documentation]
HART			(HART® compatible output, where specified, only for HART® software version 3.0.0 or higher) HART® is a registered trademark of the HART® Communication Foundation
	Configure		Individual module settings
		Source	Select from list ↓→ Off, Channel 1, Channel 2
		Units	Select and assign units (ENTER selects, 0 cancels selection, ESC exits menu) ↓→ <ul style="list-style-type: none"> P – Primary Value PV S – Secondary Value SV (optional) T – Third Value TV (optional) F – Fourth Value FV or QV (optional)
		Min. Value	Minimum value of the primary process variable (PV) corresponding to a current of 4 mA: -10 000 ... 10 000
		Max. Value	Maximum value of the primary process variable (PV) corresponding to a current of 20 mA: -10 000 ... 30 000
M-Bus			M-Bus communication
	Configure		Individual module settings
		Address	Primary address input is immediately after selecting “WIRED M-BUS” in the inputs/outputs menu Enter the primary address of the encoder: 1 ... 250
		Baud Rate	Selection of the baud rate ↓→ 300, 600, 1 200, 2 400, 4 800, 9 600, 19 200, 38 400 baud
Other In/Out types			Refer to Technical Support
System			
	Instrument Info		

Main menu	Menu level 1	Menu level 2	Description/settings
		Model Code	KATflow 170
		Serial No.	(Serial number) Example: 17024001
		HW Revision	Example: 4.00, 4.1
		SW Revision	Example: 6.06.01.0, 5.4 KAT
	Calculation		
		Select Channel	Select channel 1, channel 2
		Low Flow Cut-Off	± Low flow velocity cut-off: 0 ... 1 m/s
		High Flow Cut-Off	± Maximum flow velocity cut-off: 0 ... 30 m/s
		Corrected	Apply flow velocity profile correction: Yes/No
		PV Offset	Calibration process variable zero offset: -30 ... 30 m/s
		PV Scaling	Calibration process variable gradient scaling: -10.0 ... 10.0
		Zero Calibration	Zero calibration settings Adjust: <ul style="list-style-type: none"> • Zero (Yes/No): Sets current flow as zero (Perform auto zero calibration) • Track (Yes/No): Zero follows output variations • Delta time: Zero flow offset in ns (Zero flow delta time offset in ns, read from sensor PROM or entered directly for special sensors) • Time Up: Transit time offset in µs, for delays in special sensors, thermal buffers and cable extensions
		Window Offset	Manual delay of the measuring window: -25 ... 25 µs
		Math Function	Select from list ↕ None, Sum, Difference, Average (mean), Maximum
		Missed Measurements	Setting for the behaviour of the output values when too many unsuccessful measurements occur: <ul style="list-style-type: none"> • Hold Value: Output value of the last successful measurement • Go to Zero: Output value becomes 0 • User Value: User-specific error value: -1 ... 300 000 m/s
	User		
		Identifier	Example: Pump P3A (9 character string possible)
		Tag No.	(Tag Number) Example: 1FT-3011 (9 character string possible)
	Test		
		Installation	Control system simulation 60 second ramping up of flow velocity in m/s from 0 to programmed High Flow Cut-Off and subsequent 60 second ramping down All configured outputs will exhibit their programmed behaviour Test Mode: Yes/No
		Display	Display screen test routine
		Keypad	Keypad test routine
		Memory	Memory test routine Memory erase: Yes/No

KATflow 170

COMMISSIONING

Main menu	Menu level 1	Menu level 2	Description/settings
		Peripherals	Unit temperature, time, date, clock
		Ultrasonics	Tests ultrasonic board and sensors
	Settings		
		Date	Example: 14/02/24
		Time	Example: 09:27
		Date Format	Select from list ↓→ <ul style="list-style-type: none"> • dd/mm/yy • mm/dd/yy • yy/mm/dd
		Language	Select from list (as available) ↓→ English, German, French, Spanish, Russian
		Keypad	Enable keypad sound: Yes/No
	Timer Mode		Device starts measurement for the set measuring period <ul style="list-style-type: none"> • Activate timer mode: Yes/No • Input Start Time • Input End Time Note: Measurement does not start automatically The programmed measurement must be activated once via “Start measurement” Device gives confirmation at the set time interval
	Load Defaults		Load default settings (except date and time): Yes/No
	Measurement Mode		Selection of the measuring method: <ul style="list-style-type: none"> • Normal: Standard measuring mode • Doppler: Doppler measurement mode • Auto: Automatic selection of standard or Doppler measurement mode • Fast: Fast mode (Measuring mode with the smallest possible measuring cycle time. No indication of the measured value on the display. Output via serial interface and/or by storing the measured values in the internal data logger)
	Measurement Period		Selection of the waiting time between two measurements: 1 ... 3 600 s Note: If the Saver Mode is activated, the measurement period changes automatically from seconds to minutes.
Diagnostics			Shows internal error messages (error flags), measured temperature, available logger memory Acknowledge error message with ENTER or quit the error display with ESC Further displays of temperature, data memory, etc.
Data Logger			
		Interval	Enter logging interval in seconds: 0 ... 3 600 s

Main menu	Menu level 1	Menu level 2	Description/settings
		Selection	Select from list ↓→ ENTER selects and deselects Up to ten variables may be logged Note: When “dB Signal” and “dB SNR” are selected, two variables are stored in each case, since one measurement is performed with the flow direction (D – downstream) and one against the flow direction (U – upstream) (This applies to ultrasonic board version 5.0 or higher).
		Low Memory	Warning output 4 ... 100 %
		Log Wrap	Yes/No Output of selected values as continuous data streams with header Note: Only one measurement session can be recorded in this mode
		Log Download	Sends all logger data using serial port
		Log Erase	Clears the logger
Serial Communication			
		Mode	Select from list ↓→ <ul style="list-style-type: none"> • None • Printer (output every second of selected values) • Diagnostic • Download (send logger data using serial port) • Calibration Test (laboratory calibration, not recommended for field or customer use)
		Baud	Select from list ↓→ <ul style="list-style-type: none"> • 9 600 (default) • 19 200 • 38 400 • 57 600 • 115 200 • 230 400
		Parity	Select from list ↓→ <ul style="list-style-type: none"> • None • Even (default) • Odd
Scope			Scope function can be accessed in the sensor positioning screen by pressing ALT or in Direct Access by entering code 5
			Shows the received acoustic pulse and further data to evaluate the signal quality as a scope function on channel 1 and channel 2 (upstream and downstream) (see Section 6.8) <ul style="list-style-type: none"> • Exit screen: ESC • Sampling window +6 : UP • Sampling window -6 : RIGHT • Switching the display flow direction: ENTER

Table 15: Menu structure KATflow 170

KATflow 170

COMMISSIONING

6.2 Output configuration

The KATflow 170 has 5 Input/Output slot positions which can be configured with 5 individual I/O modules. Two slots occupy 4-wire terminals (1 to 4) whereas three slots use only 2-wire connection terminals (please refer to Picture 13).

The assignment of slots is detected by the flowmeter, and will be as shown in the “Inputs/Outputs” menu. The following picture shows an example assignment with a passive current input on slot 1 (line 1) and an active current output on slot 2 (line 2).

Since the input and output modules can be freely configured, it is advisable to ask for your individual project connection diagram.

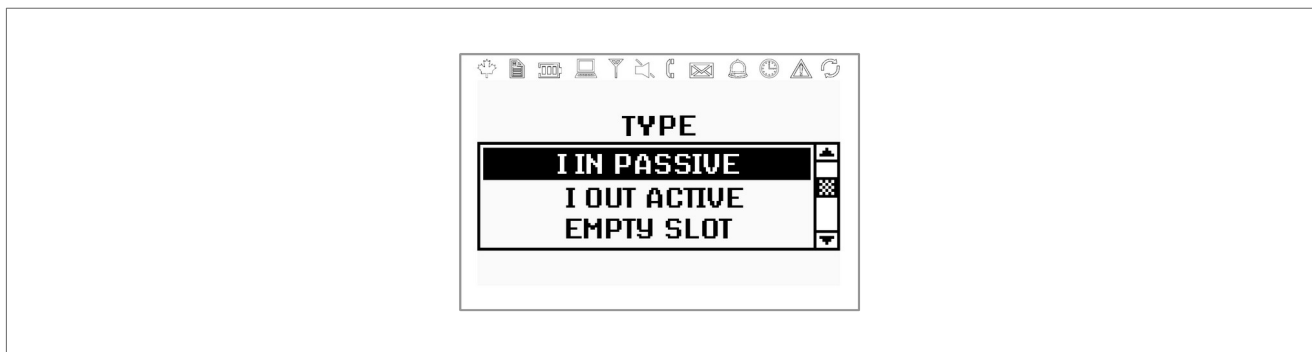

Picture 16: Display example passive current input

6.2.1 Serial interface

The RS 232 serial interface can be used to transmit data online over distances up to 15 m, to download the integral data logger content, for device configuration and maintenance tasks or to communicate with peripheral equipment. The settings can be found in the “Serial Communication” submenu.

6.2.2 Modbus RTU

The interface is used for networking up to 32 flowmeters to a centralised computer system. Each flowmeter is given a unique address to be able to communicate effectively. The communication protocol used conforms to the conventions of the Modbus RTU protocol, a description of which is given in a separate document. Please refer to Customer Support for further information.

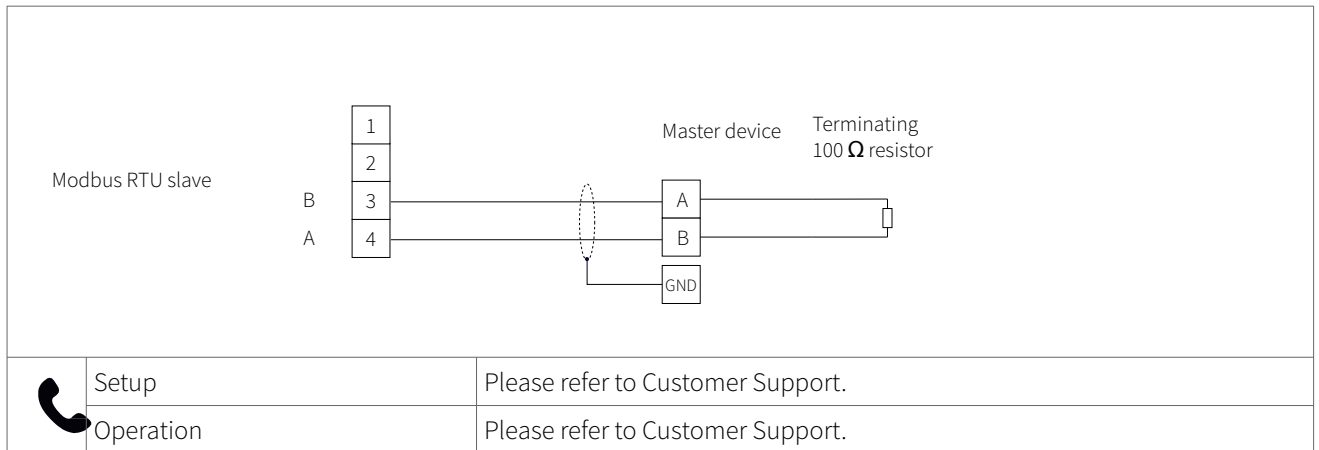

Table 16: Wiring Modbus RTU

6.2.3 HART® compatible output

The KATflow 170 can also be configured with an optional module which responds to output commands conforming to the HART® protocol. Please refer to Customer Support for further information.

HART® is a registered trademark of the HART Communication Foundation.

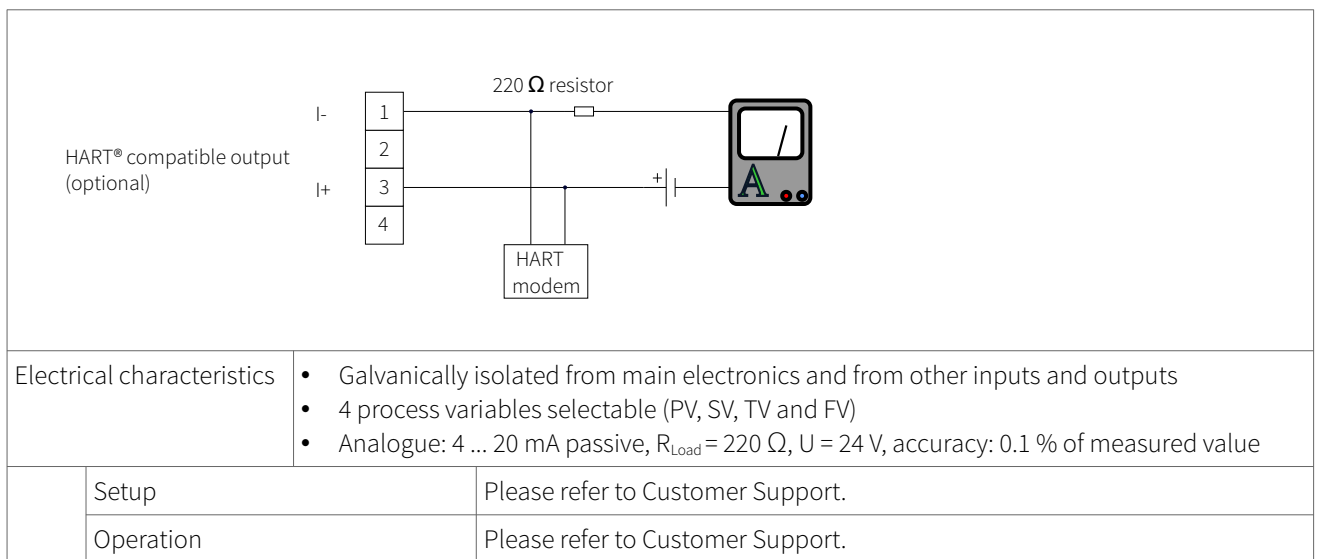

Table 17: Wiring HART® compatible output

6.2.4 Analogue current output 0/4 ... 20 mA

The analogue current outputs operate in a 4 ... 20 mA (active or passive) or 0 ... 20 mA (active) span.

Current outputs may be assigned to process values in the “Mode” section of the output menu. The outputs can be programmed and scaled within the menu structure.

KATflow 170

COMMISSIONING

<p>Active current output (optional)</p>		<p>0/4 ... 20 mA, load < 500 Ω</p>
<p>Passive current output (optional)</p>		<p>4 ... 20 mA, load < 500 Ω</p>
<p>Electrical characteristics</p>	<ul style="list-style-type: none"> • 0/4 ... 20 mA active and 4 ... 20 mA passive options • Galvanically isolated from main electronics and from other inputs and outputs • Active: $U = 30\text{ V}$, $R_{\text{Load}} < 500\ \Omega$, 16 bit resolution, accuracy: 0.1 % of measured value • Passive: $U = 9 \dots 30\text{ V}$, $R_{\text{Load}} < 500\ \Omega$, 16 bit resolution, accuracy: 0.1 % of measured value 	

Table 18: Wiring analogue current output 0/4 ... 20 mA

6.2.5 Analogue voltage output 0 ... 10 V

Voltage outputs may be assigned to process values in the “Mode” section of the output menu. The outputs can be programmed and scaled within the menu structure.

<p>Voltage output (optional)</p>	
<p>Electrical characteristics</p>	<ul style="list-style-type: none"> Galvanically isolated from main electronics and from other inputs and outputs Range: 0 ... 10 V $R_{Load} = 1 \text{ k}\Omega$, $C_{Load} = 200 \text{ pF}$ Resolution: 16 bit, accuracy: 0.1 % of measured value

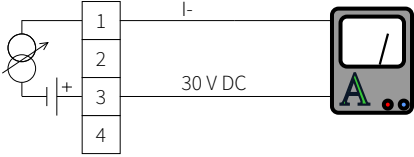
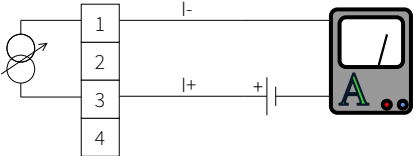
Table 19: Wiring analogue voltage output 0 ... 10 V

6.2.6 Analogue frequency output (passive)

Frequency outputs may be assigned to process values in the “Mode” section of the output menu. The outputs can be programmed and scaled within the menu structure.

<p>Frequency (analogue output) (optional)</p>	
<p>Electrical characteristics</p>	<ul style="list-style-type: none"> Galvanically isolated from main electronics and from other inputs and outputs 2 Hz ... 10 kHz $U = 24 \text{ V}$, $I_{max} = 4 \text{ mA}$

Table 20: Wiring analogue frequency output (passive)

KATflow 170

COMMISSIONING

6.2.7 Digital open-collector output

Open-collector outputs may be assigned to process values in the “Mode” section of the output menu. The outputs are configured using the menu structure.

The totaliser function is enabled and controlled using the menu structure.

<p>Digital output "Open-Collector" (optional)</p>		<p>Configurable Error, Limit, Total Pulse</p>
<p>Electrical characteristics</p>	<ul style="list-style-type: none"> Galvanically isolated from main electronics and from other inputs and outputs Function: Alarm or Totaliser Totaliser value: 0.01 ... 1 000/unit Width: 1 ... 990 ms U = 24 V, I_{max} = 4 mA NO and NC contacts 	

Table 21: Wiring digital open-collector output

6.2.8 Digital relay output

Relay outputs may be assigned to process values in the “Mode” section of the output menu. The relay outputs are configured using the menu structure.

<p>Digital relay output (optional)</p>		<p>Configurable Error, Limit, Total Pulse</p>
<p>Electrical characteristics</p>	<ul style="list-style-type: none"> Galvanically isolated from main electronics and from other inputs and outputs Function: Alarm or Totaliser Totaliser value: 0.01 ... 1 000/unit Width: 1 ... 990 ms U = 48 V, I_{max} = 250 mA NO and NC contacts 	

Table 22: Wiring digital relay output

6.3 Input configuration

6.3.1 Pt 100 inputs

Temperature input Pt 100 4-wire (optional)		Pt 100 temperature sensor
Electrical characteristics	<ul style="list-style-type: none"> • Pt 100 options: three- or four-wire circuit • Galvanically isolated from main electronics and from other inputs and outputs • Measurement range: -50 ... +400 °C (-58 ... +752 °F) • Resolution: 0.01 K, accuracy: ±0.02 K 	

Table 23: Wiring Pt 100 inputs

6.3.2 Analogue current input 0/4 ... 20 mA

Passive analogue input (optional)		4 ... 20 mA, passive input
Active analogue input (optional)		0/4 ... 20 mA, active input
Electrical characteristics	<ul style="list-style-type: none"> • 0/4 ... 20 mA active or 4 ... 20 mA passive • U = 30 V, R_i = 50 Ω, accuracy: 0.1 % of measured value 	

Table 24: Wiring analogue current input 0/4 ... 20 mA

6.4 Temperature compensation

With temperature compensation enabled the temperature dependency of the medium in relation to speed of sound, viscosity and density calculations will be compensated. The “Inputs/Outputs” menu will then allow the user to select the temperature input source, either Pt 100 temperature sensors or via a 0/4 ... 20 mA input channel.

KATflow 170

COMMISSIONING

6.5 Heat quantity measurement

Where equipped, heat quantity (energy) and heat flow (energy flow) can be measured. If a heat quantity unit is specified for the process value, the KATflow 170 will ask the user for the specific heat capacity of the medium in J/g/K (for example 4.186 J/g/K for water).

The output options menu for the Pt 100 will allow the user to select the temperature input source; either Pt 100 temperature sensors or a fixed value for measurement against a known inlet or outlet temperature. Where Pt 100 sensors are selected, the Wizard will prompt the user for a temperature offset, which may be useful where the temperature of the medium differs from the temperature of the pipe wall (for example with unlagged pipes). If a fixed value is selected, the user will be asked to specify this value.

When heat quantity units are selected, these behave as any other process value and may be totalised, logged, or applied to a process output.

6.6 Sound velocity measurement

The measured speed of sound (SOS) is available as a diagnostic function during measurement and may be applied to a process output by selecting “c” from the appropriate output menu.

6.7 Dual-channel flow calculations

Where suitably equipped, dual-channel calculations are available from the System - Calculation - Math menu. These allow the user to select the Sum, Difference, Average (mean) or Maximum of the two flow channels. This value may be displayed or applied to a process output by selecting “Math” from the appropriate output menu.

6.8 Scope function

Katronic flowmeters have an additional scope function which shows a representation of the pulse received by the sensors on channel 1 and channel 2. For each active channel the measuring direction (with or against the flow direction) can be selected. The measuring direction can be switched with **ENTER** and is indicated by an abbreviation (e. g. 1U = channel 1, upstream) at the top right of the graph. In addition to displaying the received pulse, this screen lists the data given from top to bottom (see Picture 17).

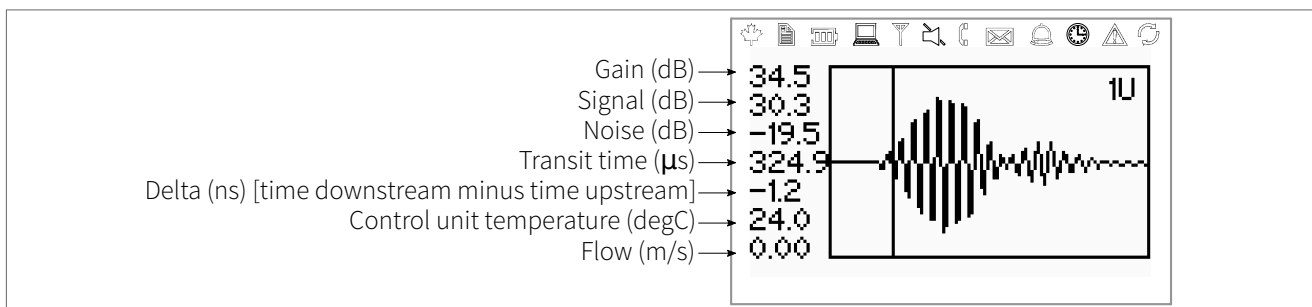

Picture 17: Scope function display

6.9 KATdata+ software

Software can be provided for downloading the contents of the data logger and communication with the flowmeter.

KATflow 170

MAINTENANCE

7 MAINTENANCE

The KATflow 170 flowmeters are maintenance free concerning the flow measurement functions. Within the scope of periodic inspections required for electrical equipment installed in hazardous areas, regular inspection for signs of damage or corrosion is recommended for the transducers, the junction box (if installed) and the explosion-proof flowmeter housing.

7.1 Opening/closing the Ex d compartment



The following instructions must always be carefully followed if opening the Ex d compartment of the KATflow 170 flowmeter. Ensure similar care is taken to close it when work is complete.

Before opening:

- Make certain that there is no explosion hazard.
- Site policies must be followed and all required documentation obtained before commencing work.
- Make sure that all connecting cables are safely isolated from all external sources.
- Allow the electronics to de-energize before opening the electronics compartment of the explosion-proof housing. Wait at least ten minutes before opening.
- When the instructions above have been strictly followed, the cover of the explosion-proof compartment may be opened. Unlock the locking screw and carefully turn the cover.

Closing:

- Screw the cover of the Ex d compartment and tighten it firmly and lock it with the locking screw using a suitable Allen key.

7.2 Service/Repair

The KATflow 170 flowmeters have been carefully manufactured and tested. If installed and operated in accordance with the operating instructions, no problems are usually experienced.

Should you nevertheless need to return a device for inspection or repair, please pay attention to the following points:



- Due to statutory regulations on environmental protection and safeguarding the health and safety of our personnel, the manufacturer may only handle, test and repair returned devices that have been in contact with products without risk to personnel and environment.
- This means that the manufacturer can only service this device if it is accompanied by a Customer Return Note (CRN) confirming that the device is safe to handle.

If the device has been operated with toxic, caustic, flammable or water-endangering products, you are kindly requested:



- To check and ensure, if necessary by rinsing or neutralising, that all cavities are free from such dangerous substances,
- to enclose a certificate with the device confirming that is safe to handle and stating the product used.

KATflow 170

TROUBLESHOOTING

8 TROUBLESHOOTING

8.1 Measurement difficulties and error messages

Most problems with measurement are due to poor signal strength or quality. Initial checks should include:

- Has sufficient acoustic coupling paste been applied?
- Can the number of sound passes be changed? As a general rule, more passes will improve accuracy, fewer passes will give better signal strength.
- Are there any nearby sources of noise or disturbance?
- Can the signal be improved by moving the sensors around the circumference of the pipe?
- Are the application parameters correct?

Should there be the need to call Customer Service, please let us know the following details:



- Model code,
- Serial number,
- SW, HW revision,
- Error log list.

Possible error messages may include the following:

Error message	Group	Description	Error handling
ULTRASONIC FAIL CYCLE POWER	Hardware	Internal ultrasonic board communication error at power up	Power off/on, otherwise call Customer Support
NO SERIAL NUMBER CYCLE POWER	Hardware	Failed to read from system memory	Power off/on, otherwise call Customer Support
NO VERSION NUMBER CYCLE POWER	Hardware	Failed to read the ultrasonic board's version number	Power off/on, otherwise call Customer Support
PARAMETER XX READ ERROR	Hardware	Failed to read from system memory	Load defaults, otherwise call Customer Support
PARAMETER XX WRITE ERROR	Hardware	Failed to write to system memory	Call Customer Support
MEASUREMENT STOPPED REASON: COM ERRORS RESTARTING	Hardware	Too many internal ultrasonic board communication errors	Call Customer Support
LOADING FAILED	Hardware	Failed to read a stored setup from system memory	Call Customer Support

Error message	Group	Description	Error handling
MENU ERROR	Hardware, Software	Failed to load a menu	Call Customer Support
PLEASE LOAD KF-TABLES DATA VERSION X.X.X XXX	Software	The external system memory is empty or an incompatible dataset was detected	Power on/off, otherwise call Customer Support
TRANSLATION FAILED	Hardware, Software	Failed to load the chosen language from the system memory	Call Customer Support
BAD SENSOR COUPLING	Application	Weak sensor coupling, low SNR	Recouple sensors, check installation, reduce number of passes, look for other location, then have a cup of tea and call Customer Support!

Table 25: Error list

For all other error messages, please turn off and restart the flowmeter and if messages continue call Customer Support.

KATflow 170

TROUBLESHOOTING

8.2 Data download difficulties

If difficulties are encountered downloading the logger data:

- Check that the flowmeter is switched on and not in measurement mode.
- Check that the same number COM port is allocated in the “Device Manager” (or equivalent) as is set in the KATdata+ software.
- Check that the settings (baud, parity, word length, stop bits) are identical.
- Use the supplied connectors – whether connecting to a 9-pin COM port or converting from serial communication to a Universal Serial Bus (USB).

9 TECHNICAL DATA

9.1 Sound speed of selected pipe materials

Material	Sound speed* shear wave (at +25 °C)	
	m/s	ft/s
Steel, 1 % Carbon, hardened	3 150	10 335
Carbon steel	3 230	10 598
Mild steel	3 235	10 614
Steel, 1 % Carbon	3 220	10 565
302 Stainless steel	3 120	10 236
303 Stainless steel	3 120	10 236
304 Stainless steel	3 141	10 306
304L Stainless steel	3 070	10 073
316 Stainless steel	3 272	10 735
347 Stainless steel	3 095	10 512
“Duplex” stainless steel	2 791	9 479
Aluminium	3 100	10 171
Aluminium (rolled)	3 040	9 974
Copper	2 260	7 415
Copper (annealed)	2 325	7 628
Copper (rolled)	2 270	7 448
CuNi (70 % Cu 30 % Ni)	2 540	8 334
CuNi (90 % Cu 10 % Ni)	2 060	6 759
Brass (Naval)	2 120	6 923
Gold (hard-drawn)	1 200	3 937
Inconel	3 020	9 909
Iron (electrolytic)	3 240	10 630
Iron (Armco)	3 240	10 630
Ductile iron	3 000	9 843
Cast iron	2 500	8 203
Monel	2 720	8 924
Nickel	2 960	9 712
Tin (rolled)	1 670	5 479
Titanium	3 125	10 253
Tungsten (annealed)	2 890	9 482
Tungsten (drawn)	2 640	8 661
Tungsten carbide	3 980	13 058
Zinc (rolled)	2 440	8 005
Glass (pyrex)	3 280	10 761
Glass (heavy silicate flint)	2 380	7 808
Glass (light borate crown)	2 840	9 318
Nylon	1 150	3 772
Nylon, 6-6	1 070	3 510
Polyethylene (LD)	540	1 772
PVC, CPVC	1 060	3 477
Acrylic resin	1 430	4 690
PTFE	2 200	7 218

Table 26: Technical data pipe material

*Note these values are to be considered nominal. Solids may be inhomogeneous and anisotropic. Actual values depend on exact composition, temperature, and to a lesser extent, on pressure and stress.

KATflow 170

TECHNICAL DATA

9.2 Technical data of selected fluids

All data given at +25 °C (+77 °F) unless otherwise stated				Sound speed			Change of sound speed per °C		Viscosity (kinematic)				
Substance	Chemical formula	Density g · cm ⁻³		m · s ⁻¹		ft · s ⁻¹		m · s ⁻¹ · °C ⁻¹	mm ² · s ⁻¹		10 ⁻⁶ · ft ² · s ⁻¹		
Acetic acid, anhydride	(CH ₃ CO) ₂ O	1.082	20 °C	1 180.0		3 871.4		2.50		0.769		8.274	
Acetic acid, nitrile	C ₂ H ₃ N	0.783		1 290.0		4 232.3		4.10		0.441		4.745	
Acetic acid, ethyl ester	C ₄ H ₈ O ₂	0.901		1 085.0		3 559.7		4.40		0.467		5.025	
Acetic acid, methyl ester	C ₃ H ₆ O ₂	0.934		1 211.0		3 973.1				0.407		4.379	
Acetone	C ₃ H ₆ O	0.791		1 174.0		3 851.7		4.50		0.399		4.293	
Acetylene dichloride	C ₂ H ₂ Cl ₂	1.260		1 015.0		3 330.1		3.80		0.400		4.304	
Acetylene tetrachloride	C ₂ H ₂ Cl ₄	1.595		1 147.0		3 763.1		3.80		1.156	15 °C	12.440	15 °C
Alcohol	C ₂ H ₆ O	0.789		1 207.0		3 960.0		4.00		1.396		15.020	
Ammonia	NH ₃	0.771		1 729.0	-33 °C	5 672.6	-27 °C	6.68		0.292	-33 °C	3.141	-27 °F
Benzene	C ₆ H ₆	0.879		1 306.0		4 284.8		4.65		0.711		7.650	
Benzol	C ₆ H ₆	0.879		1 306.0		4 284.8		4.65		0.711		7.650	
Bromine	Br ₂	2.928		889.0		2 916.7		3.00		0.323		3.475	
n-Butane (2)	C ₄ H ₁₀	0.601	0 °C	1 085.0	-5 °C	3 559.7	23 °C	5.80					
2-Butanol	C ₄ H ₁₀ O	0.810		1 240.0		4 068.2		3.30		3.239		34.851	
sec-Butylalcohol	C ₄ H ₁₀ O	0.810		1 240.0		4 068.2		3.30		3.239		34.851	
n-Butyl bromide (46)	C ₄ H ₉ Br	1.276	20 °C	1 019.0	20 °C	3 343.2	68 °F			0.490	15 °C	5.272	59 °C
n-Butyl chloride (22,46)	C ₄ H ₉ Cl	0.887		1 140.0		3 740.2		4.57		0.529	15 °C	5.692	59 °F
Carbon tetrachloride	CCl ₄	1.595	20 °C	926.0		3 038.1		2.48		0.607		6.531	
Carbon tetrafluoride (Freon 14)	CF ₄	1.750	-150 °C	875.2	-150 °C	2 871.5	-238 °F	6.61					
Chloroform	CHCl ₃	1.489		979.0		3 211.9		3.40		0.550		5.918	
Dichlorodifluoromethane (Freon 12)	CCl ₂ F ₂	1.516	40 °C	774.1		2 539.7		4.24					
Ethanol	C ₂ H ₆ O	0.789		1 207.0		3 960.0		4.00		1.390		14.956	
Ethyl acetate	C ₄ H ₈ O ₂	0.901		1 085.0		3 559.7		4.40		0.489		5.263	
Ethyl alcohol	C ₂ H ₆ O	0.789		1 207.0		3 960.0		4.00		1.396		15.020	
Ethyl benzene	C ₈ H ₁₀	0.867	20 °C	1 338.0	20 °C	4 890.8	68 °F			0.797	17 °C	8.575	63 °F
Ether	C ₄ H ₁₀ O	0.713		985.0		3 389.8		4.87		0.311		3.346	
Ethyl ether	C ₄ H ₁₀ O	0.713		985.0		3 231.6		4.87		0.311		3.346	

KATflow 170

TECHNICAL DATA

All data given at +25 °C (+77 °F) unless otherwise stated				Sound speed				Change of sound speed per °C		Viscosity (kinematic)			
Substance	Chemical formula	Density g · cm ⁻³		m · s ⁻¹		ft · s ⁻¹		m · s ⁻¹ · °C ⁻¹	mm ² · s ⁻¹	10 ⁻⁶ · ft ² · s ⁻¹			
Ethylene bromide	C ₂ H ₄ Br ₂	2.180		995.0		3 264.4				0.790		8.500	
Ethylene chloride	C ₂ H ₄ Cl ₂	1.253		1 193.0		3 914.0				0.610		6.563	
Ethylene glycol	C ₂ H ₆ O ₂	1.113		1 658.0		5 439.6		2.10		17.208	20 °C	185.158	68 °F
Fluorine	F	0.545	-143 °C	403.0	-143 °C	1 322.2	-225 °F	11.31					
Formaldehyde, methyl ester	C ₂ H ₄ O ₂	0.974		1 127.0		3 697.5		4.02					
Freon R12				774.2		2 540.0		6.61					
Glycol	C ₂ H ₆ O ₂	1.113		1 658.0		5 439.6		2.10					
50 % Ethylene glycol/ 50 % Water				1 578.0		5 177.0							
Isopropanol	C ₃ H ₈ O	0.785	20 °C	1 170.0	20 °C	3 838.6	68 °F			2.718		29.245	
Isopropyl alcohol (46)	C ₃ H ₈ O	0.785	20 °C	1 170.0	20 °C	3 838.6	68 °F			2.718			
Kerosene		0.810		1 324.0		4 343.8		3.60					
Methane	CH ₄	0.162	-89 °C	405.0	-89 °C	1 328.7	-128 °F	17.50					
Methanol	CH ₄ O	0.791	20 °C	1 076.0		3 530.2		292.00		0.695		7.478	
Methyl acetate	C ₃ H ₆ O ₂	0.934		1 211.0		3 973.1				0.407		4.379	
Methyl alcohol	CH ₄ O	0.791		1 076.0		3 530.2		292.00		0.695		7.478	
Methyl benzene	C ₇ H ₈	0.867		1 328.0	20 °C	4 357.0	68 °F	4.27		0.644		7.144	
Milk, homogenised				1 548.0		5 080.0							
Naphtha		0.760		1 225.0		4 019.0							
Natural gas		0.316	-103 °C	753.0	-103 °C	2 470.5	-153 °F						
Nitrogen	N ₂	0.808	-199 °C	962.0	-199 °C	3 156.2	-326 °F			0.217	-199 °C	2.334	-326 °F
Oil, Car (SAE 20a.30)		1.740		870.0		2 854.3				190.000		2 045.093	
Oil, Castor	C ₁₁ H ₁₀₀ O	0.969		1 477.0		4 845.8		3.60		0.670		7.209	
Oil, Diesel		0.800		1 250.0		4 101.0							
Oil, Fuel AA gravity		0.990		1 485.0		4 872.0		3.70					
Oil (Lubricating X200)				1 530.0		5 019.9							
Oil (Olive)		0.912		1 431.0		4 694.9		2.75		100.000		1 076.365	
Oil (Peanut)		0.936		1 458.0		4 738.5							
Propane (-45 to -130 °C)	C ₃ H ₈	0.585	-45 °C	1 003.0	-45 °C	3 290.6	-49 °F	5.70					
1-Propanol	C ₃ H ₈ O	0.780	20 °C	1 222.0	20 °C	4 009.2	68 °F						
2-Propanol	C ₃ H ₈ O	0.785	20 °C	1 170.0	20 °C	3 838.6	68 °F			2.718		29.245	

KATflow 170

TECHNICAL DATA

All data given at +25 °C (+77 °F) unless otherwise stated				Sound speed				Change of sound speed per °C	Viscosity (kinematic)			
Substance	Chemical formula	Density g · cm ⁻³		m · s ⁻¹		ft · s ⁻¹		m · s ⁻¹ · °C ⁻¹	mm ² · s ⁻¹		10 ⁻⁶ · ft ² · s ⁻¹	
Propene	C ₃ H ₆	0.563	-13 °C	963.0	13 °C	3 159.4	9 °F	6.32				
n-Propylalcohol	C ₃ H ₈ O	0.780	20 °C	1 222.0	20 °C	4 009.2	68 °F		2.549		27.427	
Propylene	C ₃ H ₆	0.563	-13 °C	963.0	-13 °C	3 159.4	9 °F	6.32				
Refrigerant 11	CCl ₃ F	1.490		828.3	0 °C	2 717.5	32 °F	3.56			8.500	
Refrigerant 12	CCl ₂ F ₂	1.516	-40 °C	774.1	-40 °C	2 539.7	-40 °C	4.24				
Refrigerant 14	CF ₄	1.750	-150 °C	875.2	-150 °C	2 871.6	-268 °F	6.61				
Refrigerant 21	CHCl ₂ F	1.426	0 °C	891.0	0 °C	2 923.2	32 °F	3.97				
Refrigerant 22	CHClF ₂	1.491	-69 °C	893.9	50 °C	2 923.2	32 °F	4.79				
Refrigerant 113	CCl ₂ F- CClF ₂	1.563		783.7	0 °C	2 571.2	32 °F	3.44				
Refrigerant 114	CClF ₂ - CClF ₂	1.455		665.3	-10 °C	2 182.7	14 °F	3.73				
Refrigerant 115	C ₂ ClF ₅			656.4	-50 °C	2 153.5	-58 °F	4.42				
Refrigerant C318	C ₄ F ₈	1,620	-20 °C	574.0	-10 °C	1 883.2	14 °F	3.88				
Sodium nitrate	NaNO ₃	1.884	336 °C	1 763.3	336 °C	5 785.1	637 °F	0.74	1.370	336 °C	14.740	637 °F
Sodium nitrite	NaNO ₂	1.805	292 °C	1 876.8	292 °C	6 157.5	558 °F					
Sulphur	S			1 177.0	250 °C	3 861.5	482 °F	-1.13				
Sulphuric Acid	H ₂ SO ₄	1.841		1 257.6		4 126.0		1.43	11.160		120.081	
Tetrachloroethane	C ₂ H ₂ Cl ₄	1.553	20 °C	1 170.0	20 °C	3 838.6	68 °F		1.190		12.804	
Tetrachloroethene	C ₂ Cl ₄	1.632		1 036.0		3 399.0						
Tetrachloromethane	CCl ₄	1.595	20 °C	926.0		3 038.1			0.607		6.531	
Tetrafluoromethane (Freon 14)	CF ₄	1.750	-150 °C	875.2	-150 °C	2 871.5	-283 °F	6.61				
Toluene	C ₇ H ₈	0.867	20 °C	1 328.0	20 °C	4 357.0	68 °F	4.27	0.644		6.929	
Toluol	C ₇ H ₈	0.866		1 308.0		4 291.3		4.20	0.580		6.240	
Trichlorofluoromethane (Freon 11)	CCl ₃ F	1.490		828.3	0 °C	2 717.5	32 °F	3.56				
Turpentine		0.880		1 255.0		4 117.5			1.400		15.064	
Water, distilled	H ₂ O	0.996		1 498.0		4 914.7		-2.40	1.000		10.760	
Water, heavy	D ₂ O			1 400.0		4 593.0						
Water, sea		1.025		1 531.0		5 023.0		-2.40	1.000		10.760	

Table 27: Technical data of fluids

9.3 Dependence between temperature and sound speed in water

Temperature		Sound speed in water	
°C	°F	m/s	ft/s
0	32.0	1 402	4 600
1	33.8	1 407	4 616
2	35.6	1 412	4 633
3	37.4	1 417	4 649
4	39.2	1 421	4 662
5	41.0	1 426	4 679
6	42.8	1 430	4 692
7	44.6	1 434	4 705
8	46.4	1 439	4 721
9	48.2	1 443	4 734
10	50.0	1 447	4 748
11	51.8	1 451	4 761
12	53.6	1 455	4 774
13	55.4	1 458	4 784
14	57.2	1 462	4 797
15	59.0	1 465	4 807
16	60.8	1 469	4 820
17	62.6	1 472	4 830
18	64.4	1 476	4 843
19	66.2	1 479	4 853
20	68.0	1 482	4 862
21	69.8	1 485	4 872
22	71.6	1 488	4 882
23	73.4	1 491	4 892
24	75.2	1 493	4 899
25	77.0	1 496	4 908
26	78.8	1 499	4 918
27	80.6	1 501	4 925
28	82.4	1 504	4 935
29	84.2	1 506	4 941
30	86.0	1 509	4 951
31	87.8	1 511	4 958
32	89.6	1 513	4 964
33	91.4	1 515	4 971
34	93.2	1 517	4 977
35	95.0	1 519	4 984
36	96.8	1 521	4 984
37	98.6	1 523	4 990
38	100.4	1 525	4 997
39	102.2	1 527	5 010
40	104.0	1 528	5 013
41	105.8	1 530	5 020
42	107.6	1 532	5 026
43	109.4	1 534	5 033
44	111.2	1 535	5 036
45	113.0	1 536	5 040
46	114.8	1 538	5 046
47	116.6	1 538	5 049
48	118.4	1 540	5 053
49	120.2	1 541	5 056

KATflow 170

TECHNICAL DATA

Temperature		Sound speed in water	
°C	°F	m/s	ft/s
50	122.0	1 543	5 063
51	123.8	1 543	5 063
52	125.6	1 544	5 066
53	127.4	1 545	5 069
54	129.2	1 546	5 072
55	131.0	1 547	5 076
56	132.8	1 548	5 079
57	134.6	1 548	5 079
58	136.4	1 548	5 079
59	138.2	1 550	5 086
60	140.0	1 550	5 086
61	141.8	1 551	5 089
62	143.6	1 552	5 092
63	145.4	1 552	5 092
64	147.2	1 553	5 092
65	149.0	1 553	5 095
66	150.8	1 553	5 095
67	152.6	1 554	5 099
68	154.4	1 554	5 099
69	156.2	1 554	5 099
70	158.0	1 554	5 099
71	159.8	1 554	5 099
72	161.6	1 555	5 102
73	163.4	1 555	5 102
74	165.2	1 555	5 102
75	167.0	1 555	5 102
76	167.0	1 555	5 102
77	170.6	1 554	5 099
78	172.4	1 554	5 099
79	174.2	1 554	5 099
80	176.0	1 554	5 099
81	177.8	1 554	5 099
82	179.6	1 553	5 095
83	181.4	1 553	5 095
84	183.2	1 553	5 095
85	185.0	1 552	5 092
86	186.8	1 552	5 092
87	188.6	1 552	5 092
88	190.4	1 551	5 089
89	192.2	1 551	5 089
90	194.0	1 550	5 086
91	195.8	1 549	5 082
92	197.6	1 549	5 082
93	199.4	1 548	5 079
94	201.2	1 547	5 076
95	203.0	1 547	5 076
96	204.8	1 546	5 072
97	206.6	1 545	5 069
98	208.4	1 544	5 066
99	210.2	1 543	5 063
100	212.0	1 543	5 063
104	220.0	1 538	5 046
110	230.0	1 532	5 026
116	240.0	1 524	5 000

Temperature		Sound speed in water	
°C	°F	m/s	ft/s
121	250.0	1 516	5 007
127	260.0	1 507	4 944
132	270.0	1 497	4 912
138	280.0	1 487	4 879
143	290.0	1 476	4 843
149	300.0	1 465	4 807
154	310.0	1 453	4 767
160	320.0	1 440	4 725
166	330.0	1 426	4 679
171	340.0	1 412	4 633
177	350.0	1 398	4 587
182	360.0	1 383	4 538
188	370.0	1 368	4 488
193	380.0	1 353	4 439
199	390.0	1 337	4 387
204	400.0	1 320	4 331
210	410.0	1 302	4 272
216	420.0	1 283	4 210
221	430.0	1 264	4 147
227	440.0	1 244	4 082
232	450.0	1 220	4 003
238	460.0	1 200	3 937
243	470.0	1 180	3 872
249	480.0	1 160	3 806
254	490.0	1 140	3 740
260	500.0	1 110	3 642

Table 28: Temperature and sound speed in water

KATflow 170

SPECIFICATION

10 SPECIFICATION

10.1 General

Measuring principle	Ultrasonic time difference correlation principle
Flow velocity range	0.01 ... 25 m/s
Resolution	0.25 mm/s
Repeatability	0.15 % of measured value, ± 0.015 m/s
Accuracy	Volume flow: $\pm 1 \dots 3$ % of measured value depending on application ± 0.5 % of measured value with process calibration Flow velocity (mean): ± 0.5 % of measured value
Turn down ratio	1/100
Gaseous and solid content of liquid media	< 10 % of volume

10.2 Flowmeter

Manufacturer	Katronic AG & Co. KG Gießbergweg 5 38855 Wernigerode Germany
Enclosure type	Explosion-proof field housing, pipe mounted
Marking	II 2G Ex db eb IIC T6 Gb
Certificate number	IBExU17ATEX1001X/IECEx IBE 17.0001X
Degree of protection	IP66 according to DIN EN 60529
Temperature limits	Temperature class T6: -20 ... +60 °C (+4 ... +140 °F)
Measurement channels	1 or 2
Power supply	100 ... 240 V AC 50/60 Hz, 9 ... 36 V DC, special versions on request
Display	LCD graphic display, 128 x 64 dots, backlit
Housing material	Copper-free aluminium, epoxy and polyurethane-coated
Dimensions	280 (h) x 140 (w) x 270 (d) mm (without cable glands)
Weight	Approx. 5.3 kg
Power consumption	< 5 W
Signal damping	0 ... 99 s
Transit time measurement rate	100 Hz (standard)
Output update time	1 s, faster rates on application
Calculation functions	Average/difference/sum/maximum (dual-channel use only)
Operating languages	Czech, Dutch, English, French, German, Italian, Romanian,

	Russian, Spanish, Turkish (others on request, maximum three)
--	--

10.3 Quantity and units of measurement

Volumetric flow rate	m ³ /h, m ³ /min, m ³ /s, l/h, l/min, l/s USgal/h (US gallons per hour), USgal/min, USgal/s bbl/d (barrels per day), bbl/h, bbl/min, bbl/s
Flow velocity	m/s, ft/s, inch/s
Mass flow rate	g/s, t/h, kg/h, kg/min
Volume	m ³ , l, gal (US gallons), bbl
Mass	g, kg, t
Heat flow	W, kW, MW (only with heat quantity measurement option)
Heat quantity	J, kJ, kWh (only with heat quantity measurement option)
Temperature	T in , T out, CU (housing temperature) in °C
Speed of sound	c in m/s
Signal quality	Signal in dB, Noise in dB, SNR (signal-to-noise ratio)

10.4 Internal data logger

Storage capacity	In excess of one million data points (16 MB)
Logging data	Up to ten selected variables

10.5 Communication

Serial interface	RS 485 (optional), Modbus RTU (optional), HART® compatible output, Profibus PA (optional)
Data	Instantaneous measured value, parameter set and configuration, logged data

10.6 KATdata+ software

Functionality	Download of measured values/parameter sets, graphical presentation, list format, export to third party software, online transfer of measured data
Operating systems	Windows 10, 11, Linux, Mac (optional)

KATflow 170

SPECIFICATION

10.7 Process inputs



A maximum of five input and output slots can be used.
All process inputs are galvanically isolated from the device electronics and from other inputs/outputs.

Temperature	Pt 100, three- or four-wire circuit Measurement range: -50 ... +400 °C (-58 ... +752 °F) Resolution: 0.01 K, accuracy: ±0.02 K
Current	0/4 ... 20 mA active or 4 ... 20 mA passive, U = 30 V, R _i = 50 Ω, accuracy: 0.1 % of measured value



Further process inputs available on application.

10.8 Process outputs



A maximum of five input and output slots can be used.
All process outputs are galvanically isolated from the device electronics and from other inputs/outputs.

Current	0/4 ... 20 mA active and 4 ... 20 mA passive options Active: U = 30 V, R _{Load} < 500 Ω, 16 bit resolution, accuracy: 0.1 % of measured value Passive: U = 9 ... 30 V, R _{Load} < 500 Ω, 16 bit resolution, accuracy: 0.1 % of measured value
Voltage	Range: 0 ... 10 V, R _{Load} = 1 kΩ, C _{Load} = 200 pF, resolution: 16 bit, accuracy: 0.1 % of measured value
Digital optical open-collector	Function: Alarm or Totaliser Totaliser value: 0.01 ... 1 000/unit, width: 1 ... 990 ms, U = 24 V, I _{max} = 4 mA, NO and NC contacts
Digital relay	Function: Alarm or Totaliser Totaliser value: 0.01 ... 1 000/unit, width: 1 ... 990 ms, U = 48 V, I _{max} = 250 mA, NO and NC contacts
Analogue frequency (passive)	2 Hz ... 10 kHz, U = 24 V, I _{max} = 4 mA
HART®	HART-compatible output: 4 process variables selectable (PV, SV, TV and FV) Analogue: 4 ... 20 mA passive, R _{Load} = 220 Ω, U = 24 V, accuracy: 0.1 % of measured value



Further process outputs available on application.

10.9 Clamp-on sensors: K1Ex, K4Ex

Sensor type	K1Ex	K4Ex
Pipe diameter range	50 ... 3 000 mm	10 ... 250 mm
Manufacturer	Katronic Technologies Ltd. Earls Court 13 Warwick Street Coventry CV5 6ET United Kingdom	
Ex-certification marking	Gas groups: II 2G Ex mb IIC T4 - T6 X Dust groups: II 2D Ex mbD 21 IP 68 T80 °C - T120 °C X	
Ex-certification number	TRAC09ATEX21226X	
Degree of protection	IP68 according to EN 60529	
Ex-protection method	Encapsulation (m), high level of protection (b)	
Temperature range	Temperature class T4: -50 ... +115 °C (-58 ... +239 °F) Temperature class T5: -50 ... +90 °C (-58 ... +194 °F) Temperature class T6: -50 ... +75 °C (58 ... +167 °F)	
Dimensions of sensor heads	60 (h) x 30 (w) x 34 (d) mm	
Material of sensor heads	Stainless steel	
Material of cable conduits	PTFE	
Standard cable lengths	5.0 m	



The transducers are approved for use in hazardous areas classified as Zone 1 and 2. They are connected directly to the flowmeter or via extension cables and Ex-approved junction boxes.

KATflow 170

INDEX

11 INDEX

Acoustic coupling gel	20	Outer pipe diameter	31
Analogue current input	51	Output configuration	46
Analogue current output	39, 47, 48	Packaging	5, 13
Analogue frequency output	40, 49	Passes	19, 21, 32, 37, 39, 56
Analogue voltage output	39, 49	Pipe material selection	15, 31, 37, 38, 59
Approvals	9	Pipe parameters	20
Cable glands	26, 27, 66	Pipe preparation	18
Certificate of Conformity	71	Pole	23
Commissioning	36	Process value	33, 52
Contrast	29	Pt 100 inputs	51, 68
Customer Return Note (CRN)	6, 7, 54, 73	Quick Start	31, 33, 36
Data logger	30, 35, 44, 46, 53, 67	Reflection Mode	19, 20
Diagnostic displays	33-35	Relay output	41, 50
Diagnostics	18, 44	Retaining clip (sensor mounting)	22
Diagonal Mode	19, 20, 32	Return Policy	5, 6
Digital open-collector output	40, 50	RS 232	46
Digital relay output	41, 50	Safety	5-7, 10, 25, 26, 54
Dimensions	24, 66, 69	Scope function	52
Display	28, 30, 31, 33-35, 39, 43, 46, 52, 66	Sensor configuration	19
Display icons	30	Sensor location	15, 21, 22
Disturbance sources	17, 18	Sensor mounting	14, 16, 19, 20, 22
Dual channel display mode	52	Sensor positioning screen	21, 22, 32
Dual-channel calculations	52	Sensor Separation	21, 22
Equipotential bonding	27	Serial interface	46, 67
Error messages	56	Setup Wizard	31, 32, 36
Fluid selection	31	Software KATdata+	35, 53, 58, 67
Fluid temperature	31, 36	SOS (speed of sound)	36, 52
HART® compatible output	42, 47, 67, 68	Sound velocity measurement	52
Identification of components	13	Specification	66
Input configuration	51	Storage	13, 26, 67
Installation	5, 6, 8, 9, 13, 15-17, 20, 23-27, 33, 38, 43	Switching on/off	28
Junction box	10, 14, 26, 27, 54	System configuration	14
Keypad	28, 29, 43, 44	Temperature compensation	51
Legislative requirements	7	Temperature limits	11, 66
Liner material	32, 37	Three-line display	33, 34
Maintenance	6, 46, 54	Totaliser	33, 34, 38, 50, 68
Math functions	35, 52	Transit-time method	8
Measurements	8, 15-17, 31, 32, 42	Troubleshooting	6, 56
Measuring principle	8, 66	Units of measurement	67
Menu structure	29, 34, 36, 45, 47, 49, 50	Wall thickness	15, 19, 21, 32, 37, 38
Modbus RTU	42, 46, 47, 67	Warranty	5, 6
Multiple sensors	19	Wizard (Quick Setup Wizard)	31, 32, 36
Negative separation distance	19		

12 APPENDIX A – CERTIFICATE OF CONFORMITY



Declaration of Conformity

We, Katronic Technologies Ltd., declare under our sole responsibility that the product listed below to which this declaration relates are in conformity with the EU directives and other mentioned standards:

- Directive 2014/30/EU for Electromagnetic Compatibility (EMC)
- Low Voltage Directive 2014/35/EU for Electrical Safety (LVD)
- Directive 2011/65/EU on the Restriction of Hazardous Substances (RoHS)
- ISO 2406:2023 – Measurement of fluid flow in closed conduits - Clamp-on ultrasonic transit-time meters for liquids and gases
- ASME MFC-5.1:2011 – Measurement of Liquid Flow in Closed Conduits Using Transit-Time Ultrasonic Flowmeters
- ATEX Directive 2014/34/EU – Equipment or Protective Systems or Components Intended for Use in Potentially Explosive Atmospheres

Name of Product	Description
KATflow 170	Ultrasonic flowmeter with K1Ex/K4Ex transducers

The mentioned products are in conformity with the following European Standards:

Class	Standard	Description
EMC Directive	BS EN 61326-1:2022	Electrical equipment for measurement, control and laboratory use – EMC requirements
Immunity	BS EN 61000-4-2:2009	Electrostatic discharge
	BS EN 61000-4-3:2021	RF field
	BS EN 61000-4-4:2013	Electric fast transient/burst
	BS EN 61000-4-5:2019	Surge
	BS EN 61000-4-6:2014	RF conducted
Emission	BS EN 61000-4-11:2021	AC mains voltage dips and interruption
	BS EN 61326-1:2022	Electrical equipment for measurement, control and laboratory use - EMC requirements - Part 1: General requirements
Low Voltage Directive	BS EN 55022:2010	Disturbance voltage Class A
	BS EN 61010-1:2020	Safety requirements for electrical equipment for measurement, control and laboratory use
ATEX Directive	BS EN 1127-1:2019	Explosive atmospheres. Explosion prevention and protection. Basic concepts and methodology
	BS EN 60079-0:2019	Part 0: Explosive atmospheres. Equipment. General requirements
	BS EN 60079-1:2015	Part 1: Explosive atmospheres. Equipment protection by flameproof enclosures "d"
	BS EN 60079-7:2015 +A1:2018	Part 7: Explosive atmospheres. Equipment protection by increased safety "e"
	BS EN 60079-18:2015 +A1:2017	Part 18: Explosive atmospheres. Equipment protection by encapsulation "m"
	BS EN 60079-31:2015	Part 31: Explosive atmospheres. Equipment dust ignition protection by enclosure "t"

Page 1 of 2

Katronic Technologies Ltd.
Earls Court
Warwick Street
Coventry CV5 6ET
United Kingdom

Tel. +44 (0)2476 714 111
Fax +44 (0)2476 715 446
E-mail info@katronic.co.uk
Web www.katronic.co.uk

VAT No. GB 688 0907 89
Registered in England
Number 3298028
Registered office as shown



Cert. No. 23ISO0338

KATflow 170

APPENDIX A – Certificate of Conformity



The conformity with the Directive 2014/34/EU – Annex II was certified by ATEX notified bodies with the following documents:

Name of Document	Product	Document Number
EU-Type Examination Certificate	KATflow 170	IBExU17ATEX1001X
	K1Ex/K4Ex	TRAC09ATEX21226X

Katronic Technologies Ltd. has a quality assurance system which complies with Annex IV of Directive 2014/34/EU. The quality assurance system was certified by the certification body ExVeritas ApS (ATEX notified body identification 2804):

Name of Document	Document Number
Quality Assurance Notification – Manufacturing Processes	ExVeritas 23PQAN0339

The marking of the ultrasonic flowmeter KATflow 170 includes the following:

- 2804
- Gas groups: II 2G Ex db eb IIC T6 Gb
- T_{amb} = -20 ... +60 °C

The marking of the ultrasonic transducers K1Ex/K4Ex includes the following:

- 2804
- Gas groups: II 2G Ex mb IIC T4 - T6 X
- Dust groups: II 2D Ex mbD 21 IP68 T80 °C - T120 °C X
- T_{amb} = -50 ... +115 °C

Coventry, 05 March 2024

For and on behalf of Katronic Technologies Ltd.

Yours sincerely,

Andrew Sutton
Managing Director

Katronic Technologies Ltd.
Earls Court
Warwick Street
Coventry CV5 6ET
United Kingdom

Tel. +44 (0)2476 714 111
Fax +44 (0)2476 715 446
E-mail info@katronic.co.uk
Web www.katronic.co.uk

VAT No. GB 688 0907 89
Registered in England
Number 3298028
Registered office as shown



Cert. No. 23ISO0338

13 APPENDIX B – CUSTOMER RETURN NOTE (CRN)



Company
 Name
 Tel. No.
 E-mail
 Address

Instrument model
 Serial number
 Katronic contract number (if known)
 Sensor type(s)
 Sensor serial number(s)

The enclosed instrument has been used in the following environment (please mark):

- Nuclear radiation
- Water-endangering
- Toxic
- Caustic
- Biological
- Other (please specify)

We confirm that (please mark),

- we have checked the instrument and sensors are free of any contamination,
- we have neutralised, flushed and decontaminated all parts which have been in contact with hazardous substances and/or environments,
- there is no risk to man or environment through any residual material.

Date
Signature
Company Stamp